

YFRrm

Y-SERIES | YM20

FULLY RECESSED REMODEL

SOLAIS®

PROJECT _____

TYPE _____

SPECIFICATION _____

- Upgrade to modular Solais multiples without complicated re-installation
- 120 - 277 V standard
- 0-10 V, TRIAC and ELV dimming
- Emergency backup available
- Passively cooled fixtures
- 50,000 Hours (L70)
- UL Certified for dry locations
- RoHS-compliant
- Contains no lead or mercury
- Non-IC rated; insulation must be kept 3" from sides and 1" above housing
- *MonoWhite color rendering enhancements available
- *90+ High CRI available. To order, replace 'K' in CCT designation with 'h' in code below



YFR11rm

Y-SERIES | YM20

FULLY RECESSED REMODEL

PROJECT _____

TYPE _____

SPECIFICATION _____

- Max Ceiling Thickness: 5/8"
- Ceiling Cut-Out: 5 3/4" x 5 1/2"
- Weight without module: 3 lbs.

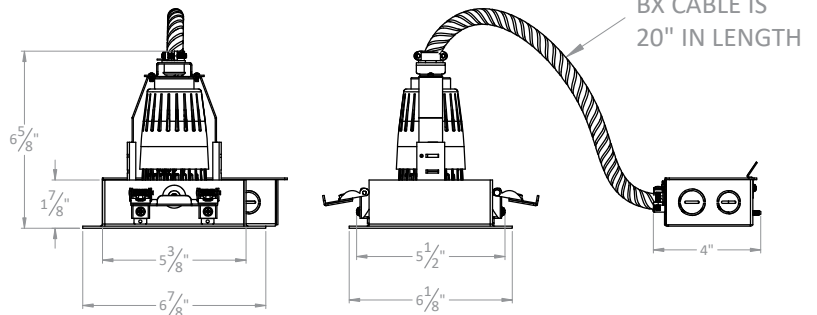

Ordering Information

Example: YFR11rm/Ym20/25/30K/1100/WH/WH/SL

Fixture	Module	Beam Spread	CCT	Lumens	Options + Accessories
YFR11rm	Ym20	15c	22K - 2200K*	1000	Options + Accessories Module Options HL - Honeycomb Louver SL - Linear Spread SP - Prismatic Spread More Accessories Available Fixture Options EM - Emergency Backup Trim Finish Die-cast, Powder Coated WH / WH - White Module, Interior + Flange PW / PW* - Pure White Module, Interior + Flange BK / BK - Black Module, Interior + Flange BK / WH* - Black Module + Interior, White Flange BK / PW* - Black Module, Interior + Flange
		25c	25K - 2500K*	1400	
		40c	27K - 2700K		
		60c	30K - 3000K		
			35K - 3500K*		
			40K - 4000K*		
			<i>MonoWhite (90 CRI)</i>		
			30m - 3000K		
			35m - 3500K*		
			<i>Dim-to-Warm (90 CRI)</i>		
		25c	D27 - 2700K to 1800K	1200	
		40c			

*Consult factory for lead time and availability

YFR12rm

Y-SERIES | YM20

FULLY RECESSED REMODEL

PROJECT _____

TYPE _____

SPECIFICATION _____

- Max Ceiling Thickness: 5/8"
- Ceiling Cut-Out: 5 3/4" x 10 1/4"
- Weight without module: 4 1/4 lbs.

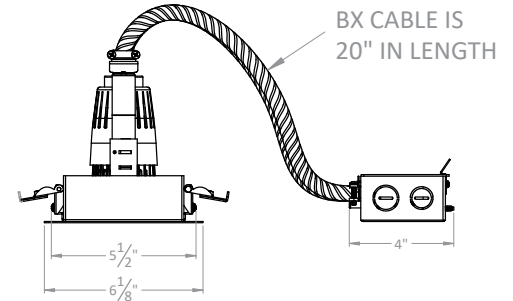
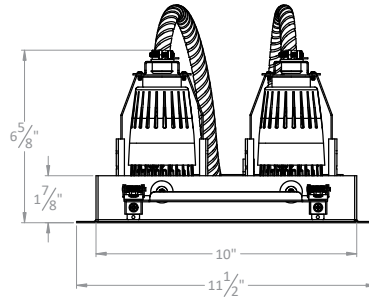

Ordering Information

Example: YFR12rm/Ym20/25-25/30K/1100/WH/WH/SL-SL

1		-		2		1		-		2	
Fixture	Module	Beam Spread	CCT	Lumens	Options + Accessories						
YFR12rm	Ym20	15c	22K - 2200K*	1000	Options + Accessories Module Options HL - Honeycomb Louver SL - Linear Spread SP - Prismatic Spread More Accessories Available Fixture Options EM - Emergency Backup Trim Finish Die-cast, Powder Coated WH / WH - White Module, Interior + Flange PW / PW* - Pure White Module, Interior + Flange BK / BK - Black Module, Interior + Flange BK / WH* - Black Module + Interior, White Flange BK / PW* - Black Module, Interior + Flange						
		25c	25K - 2500K*	1400							
		40c	27K - 2700K								
		60c	30K - 3000K								
			35K - 3500K*								
			40K - 4000K*								
			<i>MonoWhite (90 CRI)</i>								
			30m - 3000K								
			35m - 3500K*								
			<i>Dim-to-Warm (90 CRI)</i>								
		25c	D27 - 2700K to 1800K	1200							
		40c									

*Consult factory for lead time and availability

YFR13rm

Y-SERIES | YM20

FULLY RECESSED REMODEL

PROJECT _____

TYPE _____

SPECIFICATION _____

- Max Ceiling Thickness: 5/8"
- Ceiling Cut-Out: 5 3/4" x 14 3/4"
- Weight without module: 6 5/8 lbs.

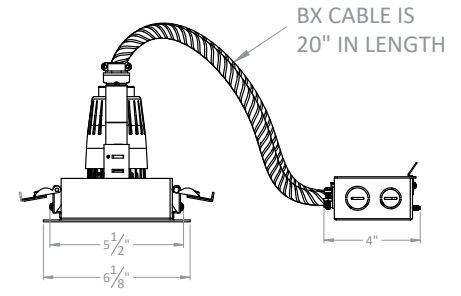
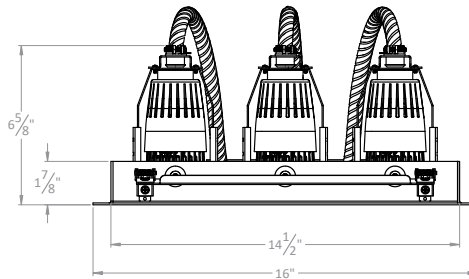
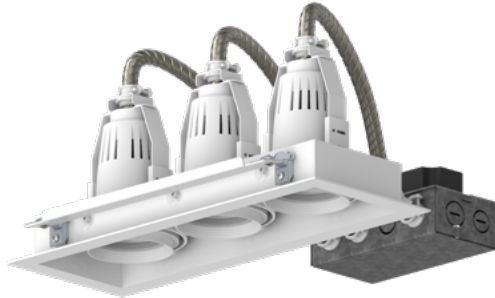

Ordering Information

Example: YFR13rm/Ym20/25-25-25/30K/1100/WH/WH/SL-SL-SL

1 - 2 - 3

1 - 2 - 3

Fixture	Module	Beam Spread	CCT	Lumens	Options + Accessories
YFR13rm	Ym20	15c	22K - 2200K*	1000	Options + Accessories Module Options HL - Honeycomb Louver SL - Linear Spread SP - Prismatic Spread More Accessories Available Fixture Options EM - Emergency Backup
		25c	25K - 2500K*	1400	
		40c	27K - 2700K		
		60c	30K - 3000K		
			35K - 3500K*		
			40K - 4000K*		
			MonoWhite (90 CRI)		
			30m - 3000K		
			35m - 3500K*		
			Dim-to-Warm (90 CRI)		
		25c	D27 - 2700K to 1800K	1200	Trim Finish Die-cast, Powder Coated WH / WH - White Module, Interior + Flange PW / PW* - Pure White Module, Interior + Flange BK / BK - Black Module, Interior + Flange BK / WH* - Black Module + Interior, White Flange BK / PW* - Black Module, Interior + Flange
		40c			

*Consult factory for lead time and availability

YFR14rm

Y-SERIES | YM20

FULLY RECESSED REMODEL

PROJECT _____

TYPE _____

SPECIFICATION _____

- Max Ceiling Thickness: 5/8"
- Ceiling Cut-Out: 5 3/4" x 19 3/8"
- Weight without module: 8 3/8 lbs.

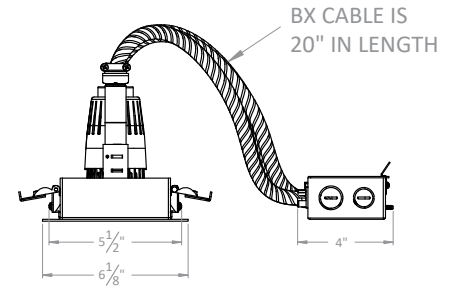
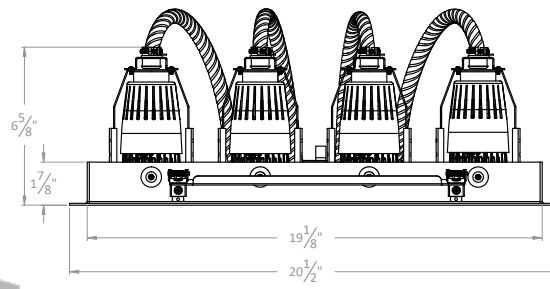
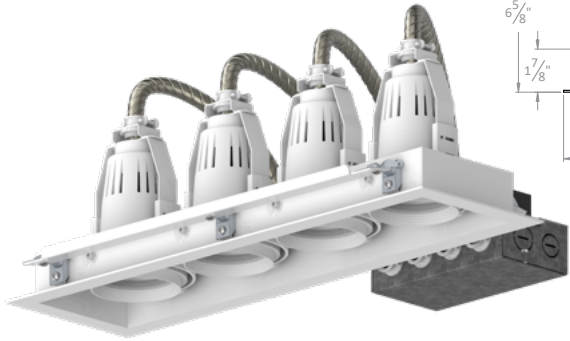

Ordering Information

Example: YFR14rm/Ym20/25-25-25-30K/1100/WH/WH/SL-SL-SL-SL



Fixture YFR14rm	Module Ym20	Beam Spread	CCT	Lumens	Options + Accessories	
		15c	22K - 2200K*	1000	Options + Accessories Module Options HL - Honeycomb Louver SL - Linear Spread SP - Prismatic Spread More Accessories Available Fixture Options EM - Emergency Backup	
		25c	25K - 2500K*	1400		
		40c	27K - 2700K			
		60c	30K - 3000K			
			35K - 3500K*			
			40K - 4000K*			
			MonoWhite (90 CRI) 30m - 3000K 35m - 3500K*			
		25c 40c	Dim-to-Warm (90 CRI) D27 - 2700K to 1800K	1200		Trim Finish Die-cast, Powder Coated WH / WH - White Module, Interior + Flange PW / PW* - Pure White Module, Interior + Flange BK / BK - Black Module, Interior + Flange BK / WH* - Black Module + Interior, White Flange BK / PW* - Black Module, Interior + Flange

*Consult factory for lead time and availability

YFRrm

Y-SERIES | YM20 FULLY RECESSED REMODEL

PROJECT _____

TYPE _____

SPECIFICATION _____

PHOTOMETRIC DETAILS | baseline X output multiplier X cri-cct multiplier = final output

Ym20 COB OPTIC: Baseline data shown below for 19 W, 1600 lumens, 80+ CRI , 3000K

Ym20/15c/30K/1600

Input Power: 19.0 W
Lumens: 1706 lm
Efficacy: 90 lm/W
CBCP: 15601
Beam Angle: 15.7°
Field Angle: 31.6°
Spacing Criteria: 0.27

∠	0°	45°	90°
0°	15423	15423	15423
5°	13235	11552	10525
10°	5840	4430	3671
15°	1892	1636	1542
20°	868	718	645
25°	370	308	286
30°	187	156	155
35°	108	89	91
40°	80	75	71
45°	75	71	61

Ym20/25c/30K/1600

Input Power: 19.1 W
Lumens: 1669 lm
Efficacy: 87 lm/W
CBCP: 7248
Beam Angle: 25.1°
Field Angle: 46.5°
Spacing Criteria: 0.45

∠	0°	45°	90°
0°	7244	7244	7244
5°	6459	6400	6436
10°	4534	4494	4597
15°	2531	2521	2627
20°	1138	1153	1225
25°	465	473	524
30°	208	210	241
35°	103	104	120
40°	50	51	58
45°	25	25	29

Ym20/40c/30K/1600

Input Power: 19.1 W
Lumens: 1619 lm
Efficacy: 85 lm/W
CBCP: 3539
Beam Angle: 36.2°
Field Angle: 66.7°
Spacing Criteria: 0.65

∠	0°	45°	90°
0°	3539	3539	3539
5°	3425	3421	3425
10°	2967	2964	2983
15°	2203	2205	2244
20°	1440	1448	1488
25°	850	855	890
30°	485	488	510
35°	271	269	283
40°	142	139	151
45°	73	72	79

Ym20/60c/30K/1600

Input Power: 17.5 W
Lumens: 1517 lm
Efficacy: 87 lm/W
CBCP: 1121
Beam Angle: 53.3°
Field Angle: 91.4°
Spacing Criteria: 1.00

∠	0°	45°	90°
0°	1118	1118	1118
5°	1089	1085	1076
10°	1030	1018	997
15°	937	922	887
20°	799	770	737
25°	632	598	576
30°	460	431	414
35°	308	287	279
40°	201	187	180
45°	126	117	108

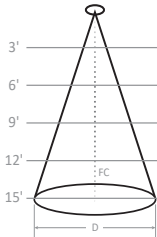

Height (FC)	Ym20/15c/30K/1600 (D)	Ym20/25c/30K/1600 (D)	Ym20/40c/30K/1600 (D)	Ym20/60c/30K/1600 (D)
3'	0.82' D; 1200 FC	1.34' D; 563 FC	1.96' D; 275 FC	3.01' D; 87 FC
6'	1.65' D; 300 FC	2.67' D; 141 FC	3.92' D; 69 FC	6.02' D; 22 FC
9'	2.47' D; 133 FC	4.01' D; 63 FC	5.88' D; 31 FC	9.03' D; 10 FC
12'	3.30' D; 75 FC	5.34' D; 350 FC	7.84' D; 17 FC	12.04' D; 5 FC
15'	4.12' D; 48 FC	6.68' D; 23 FC	9.81' D; 11 FC	15.06' D; 4 FC

CRI-CCT MULTIPLIER

CRI	CCT	Multiplier	CRI	CCT	Multiplier
8 (80+)	2200K	0.86	H (97+)	2700K	0.66
	2500K	0.91		3000K	0.71
	2700K	0.96		3500K	0.75
	3000K	1.00		4000K	0.77
	3500K	1.03	M (MonoWhite)	3000K	0.86
	4000K	1.05		3500K	0.88
9 (90+)	2200K	0.70			
	2500K	0.77			
	2700K	0.83			
	3000K	0.86			
	3500K	0.89			
	4000K	0.91			

OUTPUT MULTIPLIER

Package	Multiplier
13 W 1000 lm Ym20 COB-optic	0.65

YFRrm

Y-SERIES | YM20 FULLY RECESSED REMODEL

PROJECT _____

TYPE _____

SPECIFICATION _____

TM30 COLOR REPORTS

- 3000K with 80+ CRI
- $R_f = 84$; $R_g = 94$
- $R_A = 82$; $R_9 = 11$
- 3000K with 90+ CRI
- $R_f = 92$; $R_g = 100$
- $R_A = 93$; $R_9 = 56$
- 3000K with 97+ CRI
- $R_f = 96$; $R_g = 104$
- $R_A = 97$; $R_9 = 98$
- 3000K with MonoWhite
- $R_f = 91$; $R_g = 100$
- $R_A = 91$; $R_9 = 42$

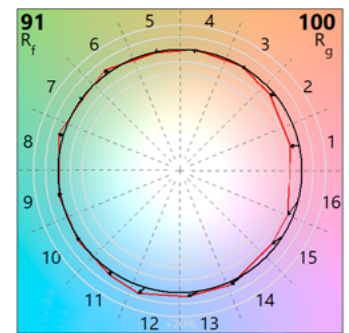
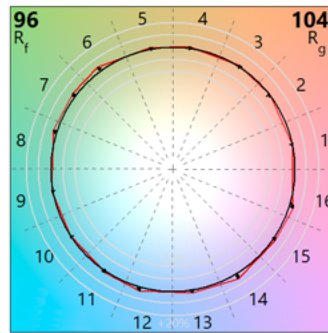
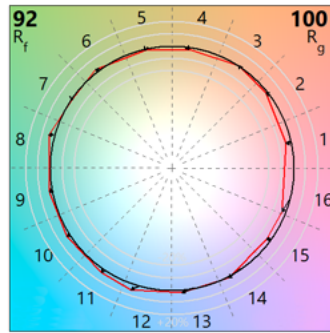
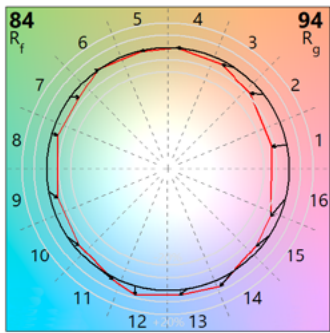
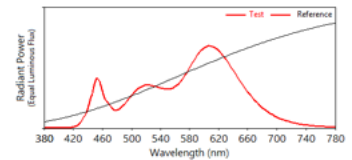
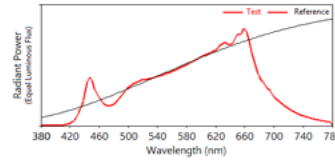
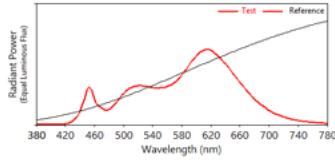
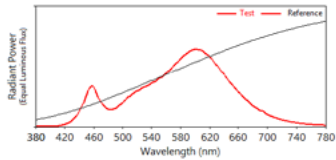

DIM TO WARM DETAILS | Dim to warm only available with 25° and 40° beam spreads; 90+CRI

- 2700K to 1800K with 90+ CRI
- $R_f = 92$; $R_g = 100$
- $R_A = 93$; $R_9 = 57$

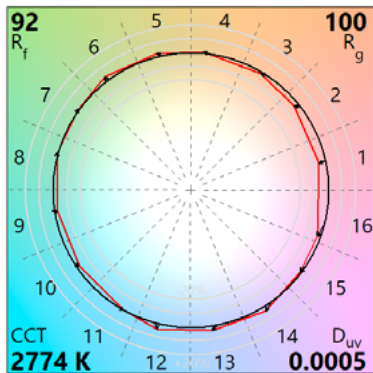
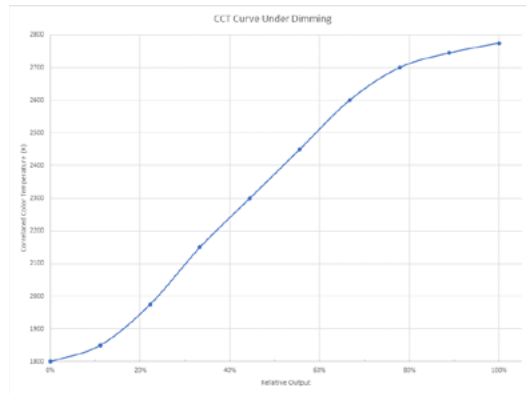
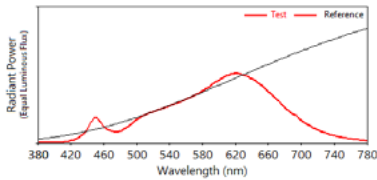

Ym20/25c/30K/1000

Input Power: 15.7 W
Lumens: 1012 lm
Efficacy: 65 lm/W
CBCP: 3537
Beam Angle: 28.0°
Field Angle: 53.4°
Spacing Criteria: 0.50

∠	0°	45°	90°
0°	3530	3530	3530
5°	3328	3305	3281
10°	2575	2546	2499
15°	1630	1619	1592
20°	894	890	874
25°	441	435	433
30°	222	216	217
35°	106	102	100
40°	43	40	40
45°	9	9	9

Ym20/40c/30K/1000

Input Power: 15.6 W
Lumens: 967 lm
Efficacy: 62 lm/W
CBCP: 2231
Beam Angle: 36.1°
Field Angle: 65.0°
Spacing Criteria: 0.65

∠	0°	45°	90°
0°	2225	2225	2225
5°	2148	2142	2128
10°	1880	1850	1824
15°	1434	1394	1366
20°	953	920	896
25°	563	540	527
30°	310	296	290
35°	157	152	149
40°	75	72	70
45°	31	30	29

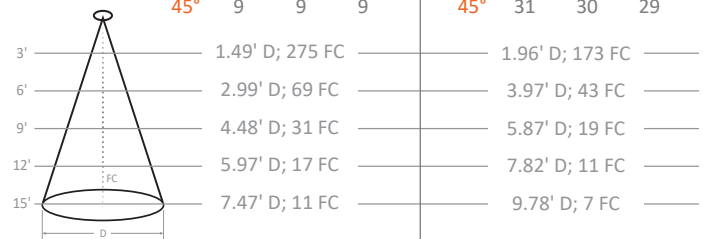

WARNING: Not for use in fully enclosed luminaires. Risk of electric shock. Use in an indoor, dry location only. This device is not intended for use with emergency exit fixtures or emergency exit lights. May not be compatible with all dimmers; please visit solais.com/dimming for up-to-date dimmer compatibility information.
NOTES: This device complies with Part 15 of the FCC Rule. This product may cause interference with other devices. If interference occurs, change the locations of the products involved. **Compatible on 120v systems.**