

Xd30

SUPER HIGH OUTPUT | 3.75-IN TRACKHEAD FIXTURE

PROJECT _____

TYPE _____

SPECIFICATION _____

- 120 V
 - Non Dimming
 - 50,000 hours (L70)
 - Integrated driver
 - 360° rotation; 0-90° head tilt
 - UL certified for dry locations
 - DesignLights Consortium® Certification (DLC) options
 - RoHS-compliant
 - Power on/off switch on adapters
 - Various mounting options
 - J-type, L-type, H-type: 1-circuit=1-neutral; Low profile adapter
 - G-type: 2-circuit=2-neutral; Compatible with Nordic TEK
 - Gx-type*: 3-circuit=1-neutral; Compatible with XTS, XTSC, GNC7, Hoffmeister, EUTRAC, iGuzzini, Zumtobel, ERCO
 - VioLight and MonoWhite* color rendering enhancements available
 - * 90+ High CRI available.
- To order, replace 'K' in CCT designation with 'h' in code below



Ordering Information

Example: Xd30/25/30K/3500/WH/J/SN

Fixture	Beam Spread	CCT / Lumens	Housing Color	Mounting	Options
Xd30	COB-optic	25K* / 2000	WH - White	J L H G Gx*	HL - Honeycomb Louver SL - Linear Spread SP - Prismatic Spread SS - Solite Spread SF - Frosted Spread More Accessories Available
	15c	27K / 2150	PW - Perfect White		
	25c	30K / 2300	SV - Silver		
	40c	30m* / 2300	BK - Black		
		35K* / 2300			
		35m* / 2300			
		40K* / 2300			
	18c	25K* / 2800			
	25c	27K / 3135			
	40c	30K / 3300			
	60c	30m* / 3300			
		35K* / 3300			
35m* / 3300					
40K* / 3300					
Multi-optic	27K* / 3500				
15	30K / 3500				
25	30v / 3500				
40	35K* / 3500				
60	40K* / 3500				
		27K* / 5000			
		30K / 5000			
		35K* / 5000			
		40K* / 5000			

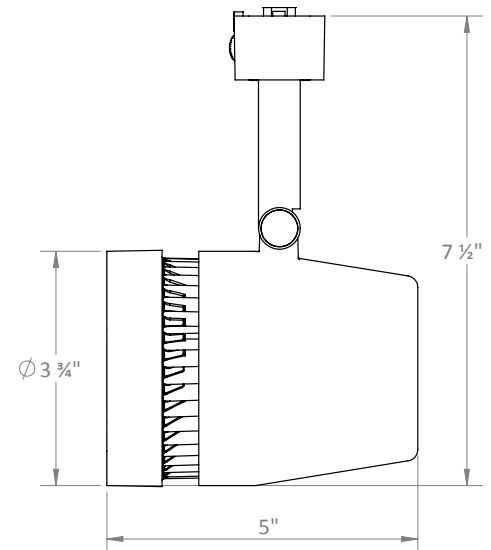

Weight: 22.4 oz.

*Consult factory for lead time and availability

Xd30

SUPER HIGH OUTPUT | 3.75-IN TRACKHEAD FIXTURE

PROJECT _____

TYPE _____

SPECIFICATION _____

PHOTOMETRIC DETAILS | baseline X output multiplier X cri-cct multiplier = final output

COB OPTIC: Baseline for 36 W, 3300 lumens, 80+ CRI, 3000K

Xd30/15c/30K/3300

Input Power: 36.4 W
Lumens: 3291 lm
Efficacy: 91 lm/W
CBCP: 17300 cd
Beam Angle: 16.1°
Field Angle: 33.6°
Spacing Criteria: 0.28

∠	0°	45°	90°
0°	17300	17300	17300
5°	12927	12605	12670
10°	5898	5641	5689
15°	2283	2214	2214
20°	1029	1006	986
25°	492	476	464
30°	232	225	225
35°	123	122	125
40°	81	80	82
45°	59	58	58

Xd30/25c/30K/3300

Input Power: 36.3 W
Lumens: 3248 lm
Efficacy: 89 lm/W
CBCP: 10041 cd
Beam Angle: 22.3°
Field Angle: 44.8°
Spacing Criteria: 0.39

∠	0°	45°	90°
0°	10041	10041	10041
5°	8830	8696	8558
10°	5862	5729	5575
15°	3143	3058	2958
20°	1477	1444	1381
25°	694	678	645
30°	342	334	319
35°	176	174	167
40°	100	100	98
45°	63	63	62

Xd30/40c/30K/3300

Input Power: 36.3 W
Lumens: 3190 lm
Efficacy: 88 lm/W
CBCP: 4346 cd
Beam Angle: 37.2°
Field Angle: 67.1°
Spacing Criteria: 0.67

∠	0°	45°	90°
0°	4343	4343	4343
5°	4182	4192	4169
10°	3632	3666	3629
15°	2828	2872	2831
20°	1957	1995	1959
25°	1202	1227	1198
30°	670	679	663
35°	354	358	350
40°	189	192	187
45°	108	110	108

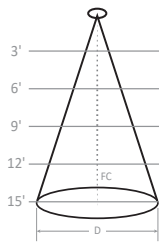

3'	0.85' D; 1346 FC
6'	1.7' D; 336 FC
9'	2.55' D; 150 FC
12'	3.39' D; 84 FC
15'	4.24' D; 54 FC

3'	1.18' D; 781 FC
6'	2.36' D; 195 FC
9'	3.54' D; 87 FC
12'	4.72' D; 49 FC
15'	5.9' D; 31 FC

3'	2.02' D; 338 FC
6'	4.04' D; 84 FC
9'	6.06' D; 38 FC
12'	8.08' D; 21 FC
15'	10.1' D; 14 FC

MULTI-OPTIC: Baseline for 45 W, 5000 lumens, 80+ CRI, 3000K

Xd30/15m/30K/5000

Input Power: 44.9 W
Lumens: 5136 lm
Efficacy: 114 lm/W
CBCP: 45736 cd
Beam Angle: 16.6°
Field Angle: 30.5°
Spacing Criteria: 0.29

∠	0°	45°	90°
0°	45685	45685	45685
5°	37283	35831	34881
10°	17375	16594	15858
15°	5326	4964	4269
20°	1801	1691	1358
25°	804	769	692
30°	471	457	418
35°	293	279	263
40°	221	201	187
45°	160	152	144

Xd30/25m/30K/5000

Input Power: 43.8 W
Lumens: 5077 lm
Efficacy: 116 lm/W
CBCP: 27200 cd
Beam Angle: 22.2°
Field Angle: 40.6°
Spacing Criteria: 0.39

∠	0°	45°	90°
0°	27160	27160	27160
5°	24314	22874	22029
10°	16228	14490	13442
15°	7965	6732	6171
20°	3047	2367	2162
25°	1064	875	801
30°	488	442	398
35°	299	278	255
40°	204	192	184
45°	145	142	138

Xd30/40m/30K/5000

Input Power: 43.8 W
Lumens: 4721 lm
Efficacy: 108 lm/W
CBCP: 8325 cd
Beam Angle: 40.8°
Field Angle: 73.0°
Spacing Criteria: 0.74

∠	0°	45°	90°
0°	8316	8316	8316
5°	7932	8001	7964
10°	7033	7214	7046
15°	5785	5994	5878
20°	4268	4430	4461
25°	2791	2890	3035
30°	1659	1700	1859
35°	933	956	1079
40°	538	554	626
45°	328	337	366

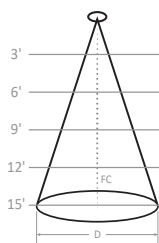

3'	0.87' D; 3553 FC
6'	1.75' D; 888 FC
9'	2.62' D; 395 FC
12'	3.49' D; 222 FC
15'	4.63' D; 142 FC

3'	1.18' D; 2112 FC
6'	2.35' D; 528 FC
9'	3.53' D; 235 FC
12'	4.71' D; 132 FC
15'	5.89' D; 85 FC

3'	2.23' D; 647 FC
6'	4.46' D; 162 FC
9'	6.69' D; 72 FC
12'	8.93' D; 40 FC
15'	11.16' D; 26 FC

OUTPUT MULTIPLIER

Package	Optic	Multiplier
23 W 2300 lm Xm20 COB-optic	15°	0.67
	25°	0.67
	40°	0.67

CRI-CCT MULTIPLIER

CRI	CCT	Multiplier
8 (80+)	2200K	0.86
	2500K	0.91
	2700K	0.96
	3000K	1.00
	3500K	1.03
9	4000K	1.05
	2200K	0.70
	2500K	0.77
	2700K	0.83
M (MonoWhite)	3000K	0.86
	3500K	0.88
V (VioLight)	3000K	0.89

OUTPUT MULTIPLIER

Package	Optic	Multiplier
30 W 3500 lm Xd30 Multi-optic	15°	0.70
	25°	0.70
	40°	0.70

Xd30

SUPER HIGH OUTPUT | 3.75-IN TRACKHEAD FIXTURE

TM30 COLOR REPORTS

- 3000K with 80+ CRI
 - $R_f = 84$; $R_g = 94$
 - $R_A = 82$; $R_9 = 11$
- 3000K with 90+ CRI
 - $R_f = 92$; $R_g = 100$
 - $R_A = 93$; $R_9 = 56$
- 3000K with 97+ CRI
 - $R_f = 96$; $R_g = 104$
 - $R_A = 97$; $R_9 = 98$
- 3000K with MonoWhite
 - $R_f = 91$; $R_g = 100$
 - $R_A = 91$; $R_9 = 42$

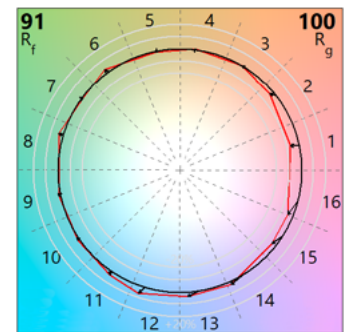
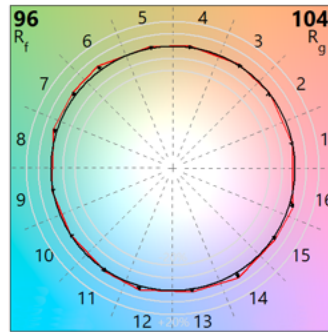
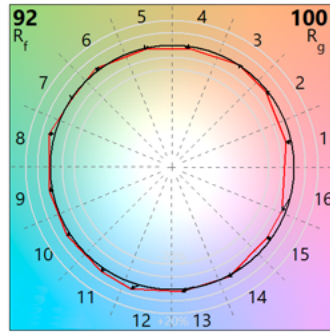
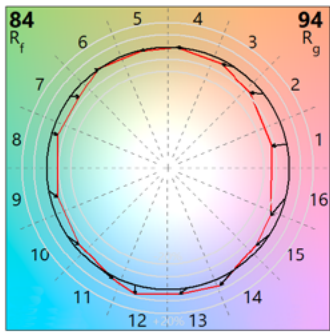
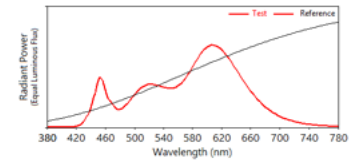
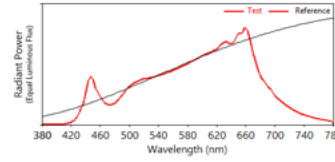
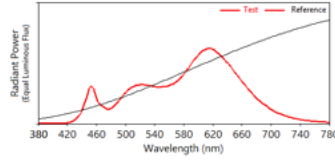
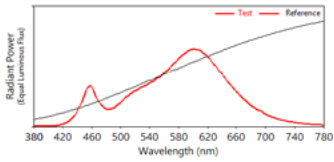

WARNING: Not for use in fully enclosed luminaires. Risk of electric shock. Use in an indoor, dry location only. This device is not intended for use with emergency exit fixtures or emergency exit lights. May not be compatible with all dimmers; please visit solais.com/dimming for up-to-date dimmer compatibility information.

NOTES: This device complies with Part 15 of the FCC Rule. This product may cause interference with other devices. If interference occurs, change the locations of the products involved. **Compatible on 120v systems.**



Thermal Throttle – In the event that Solais products begin to overheat, they will undetectably dim themselves to protect your technology investments.



Violight radiates superior quality, enhancing colors in merchandise, making colors more vibrant and offering a truly competitive LED replacement for CMH-like crispness.