

Xd24

MID-HIGH OUTPUT | 3-IN TRACKHEAD FIXTURE

PROJECT _____

TYPE _____

SPECIFICATION _____

- 120 V
 - 50,000 hours (L70)
 - Integrated driver
 - 360° rotation; 0-90° head tilt
 - UL certified for dry locations
 - DesignLights Consortium® Certification (DLC) options
 - RoHs-compliant
 - Power on/off switch on adapters
 - Triac and ELV dimming; compatibility list available
 - Various mounting options
 - J-type, L-type, H-type: 1-circuit=1-neutral; Low profile adapter
 - G-type: 2-circuit=2-neutral; Compatible with Nordic TEK
 - Gx-type*: 3-circuit=1-neutral; Compatible with XTS, XTSC, GNC7, Hoffmeister, EUTRAC, iGuzzini, Zumtobel, ERCO
 - VioLight and MonoWhite* color rendering enhancements available
 - * 90+ High CRI available.
- To order, replace 'K' in CCT designation with 'h' in code below



Ordering Information

Example: Xd24/25/30K/2000/WH/J/SN

| Fixture | Beam Spread | CCT / Lumens | Exterior Finish | Options |
|---------|-------------|--------------|---------------------|----------------------------|
| Xd24 | COB-optic | 25K* / 1400 | WH - White | HL - Honeycomb Louver |
| | 15c | 27K / 1550 | BK - Black | SL - Linear Spread |
| | 25c | 30K / 1600 | SV - Silver | SP - Prismatic Spread |
| | 40c | 30m* / 1600 | PW* - Perfect White | SS - Solite Spread |
| | 60c | 35K* / 1600 | | SF - Frosted Spread |
| | | 35m* / 1600 | | More Accessories Available |
| | | 40K* / 1600 | | |
| | | 25K* / 2000 | | |
| | | 27K / 2000 | | |
| | | 30K / 2000 | | |
| | | 30m* / 2000 | | |
| | | 35K* / 2000 | | |
| | | 35m* / 2000 | | |
| | | 40K* / 2000 | | |
| | Multi-optic | 30v / 1850 | | |
| | 15 | 27K / 2300 | | |
| | 25 | 30K / 2400 | | |
| | 40 | 35K* / 2400 | | |
| | 60 | 40K* / 2400 | | |
| | | 27K / 3000 | | |
| | | 30K / 3000 | | |
| | | 35K* / 3000 | | |
| | | 40K* / 3000 | | |

Mounting

- J
- L
- H
- G
- Gx*

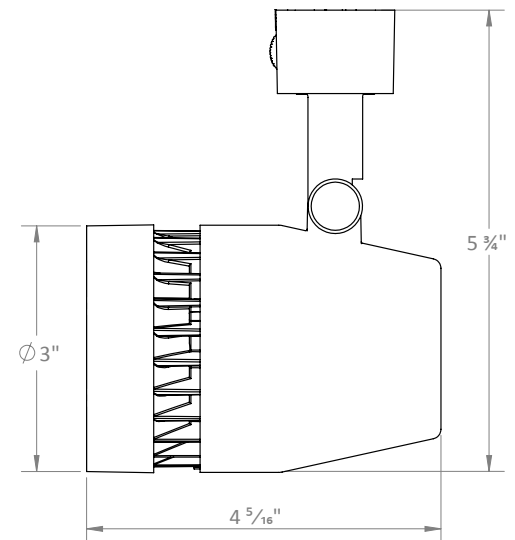

Weight: 12.8 oz.

*Consult factory for lead time and availability

Xd24

MID-HIGH OUTPUT | 3-IN TRACKHEAD FIXTURE

PROJECT

TYPE

SPECIFICATION

PHOTOMETRIC DETAILS | baseline X output multiplier X cri-cct multiplier = final output

COB OPTIC: Baseline data for 22 W, 2000 lumens, 80+ CRI, 3000K

Xd24/15c/30K/2000

| | |
|--------------|-----------|
| Input Power: | 22.5 W |
| Lumens: | 1868 lm |
| Efficacy: | 82.9 lm/W |
| Beam Angle: | 19.2° |
| Field Angle: | 49.1° |

Xd24/25c/30K/2000

| | |
|--------------|------------|
| Input Power: | 21.9 W |
| Lumens: | 2200 lm |
| Efficacy: | 100.3 lm/W |
| Beam Angle: | 23.9° |
| Field Angle: | 59.8° |

Xd24/40c/30K/2000

| | |
|--------------|-----------|
| Input Power: | 22.2 W |
| Lumens: | 2013 lm |
| Efficacy: | 90.9 lm/W |
| Beam Angle: | 38.8° |
| Field Angle: | 85.9° |

| ∠ | 0° | 45° | 90° |
|-----|------|------|------|
| 0° | 7831 | 7831 | 7831 |
| 5° | 6438 | 6425 | 6339 |
| 10° | 3671 | 3628 | 3524 |
| 15° | 1830 | 1823 | 1789 |
| 20° | 1088 | 1090 | 1069 |
| 25° | 726 | 736 | 709 |
| 30° | 501 | 516 | 496 |
| 35° | 342 | 353 | 344 |
| 40° | 233 | 238 | 236 |
| 45° | 157 | 160 | 163 |

| ∠ | 0° | 45° | 90° |
|-----|------|------|------|
| 0° | 6529 | 6529 | 6529 |
| 5° | 5797 | 5759 | 5621 |
| 10° | 4014 | 3962 | 3803 |
| 15° | 2347 | 2286 | 2202 |
| 20° | 1369 | 1344 | 1311 |
| 25° | 904 | 894 | 874 |
| 30° | 646 | 642 | 628 |
| 35° | 458 | 465 | 453 |
| 40° | 332 | 341 | 331 |
| 45° | 241 | 250 | 242 |

| ∠ | 0° | 45° | 90° |
|-----|------|------|------|
| 0° | 3023 | 3023 | 3023 |
| 5° | 2893 | 2871 | 2848 |
| 10° | 2530 | 2476 | 2437 |
| 15° | 2026 | 1961 | 1911 |
| 20° | 1511 | 1447 | 1402 |
| 25° | 1073 | 1023 | 987 |
| 30° | 749 | 716 | 690 |
| 35° | 527 | 507 | 491 |
| 40° | 380 | 368 | 357 |
| 45° | 278 | 271 | 263 |

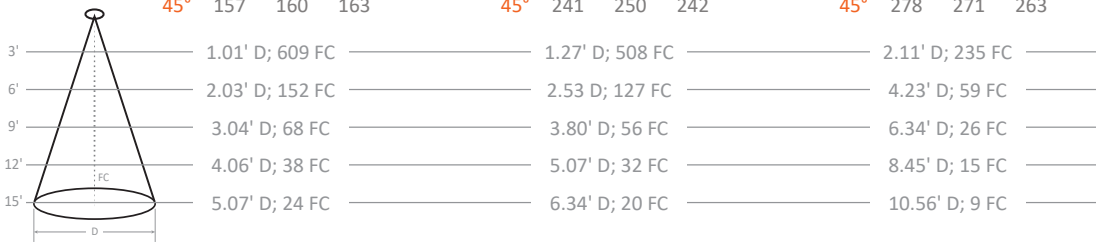

MULTI-OPTIC: Baseline data for 26 W, 2400 lumens, 80+ CRI, 3000K

Xd24/15/30K/2400

| | |
|--------------|------------|
| Input Power: | 26.4 W |
| Lumens: | 2636 lm |
| Efficacy: | 100.0 lm/W |
| Beam Angle: | 14.8° |
| Field Angle: | 26.1° |

Xd24/25/30K/2400

| | |
|--------------|-----------|
| Input Power: | 26.4 W |
| Lumens: | 2573 lm |
| Efficacy: | 97.4 lm/W |
| Beam Angle: | 27.2° |
| Field Angle: | 48.4° |

Xd24/40/30K/2400

| | |
|--------------|-----------|
| Input Power: | 26.4 W |
| Lumens: | 2385 lm |
| Efficacy: | 90.5 lm/W |
| Beam Angle: | 44.0° |
| Field Angle: | 71.7° |

| ∠ | 0° | 45° | 90° |
|-----|-------|-------|-------|
| 0° | 32012 | 32012 | 32012 |
| 5° | 23079 | 22740 | 22414 |
| 10° | 7807 | 8170 | 8147 |
| 15° | 1905 | 1732 | 1527 |
| 20° | 642 | 512 | 463 |
| 25° | 268 | 253 | 255 |
| 30° | 157 | 151 | 150 |
| 35° | 99 | 91 | 89 |
| 40° | 72 | 66 | 62 |
| 45° | 55 | 52 | 51 |

| ∠ | 0° | 45° | 90° |
|-----|------|------|------|
| 0° | 9977 | 9977 | 9977 |
| 5° | 9134 | 9161 | 9195 |
| 10° | 6880 | 6928 | 6963 |
| 15° | 4125 | 4130 | 4112 |
| 20° | 1967 | 1951 | 1931 |
| 25° | 824 | 797 | 783 |
| 30° | 367 | 340 | 323 |
| 35° | 191 | 172 | 164 |
| 40° | 111 | 103 | 99 |
| 45° | 69 | 68 | 67 |

| ∠ | 0° | 45° | 90° |
|-----|------|------|------|
| 0° | 4057 | 4057 | 4057 |
| 5° | 4083 | 3943 | 3829 |
| 10° | 3913 | 3706 | 3506 |
| 15° | 3452 | 3328 | 3021 |
| 20° | 2599 | 2596 | 2302 |
| 25° | 1651 | 1710 | 1532 |
| 30° | 913 | 969 | 889 |
| 35° | 456 | 488 | 459 |
| 40° | 221 | 238 | 225 |
| 45° | 112 | 112 | 103 |

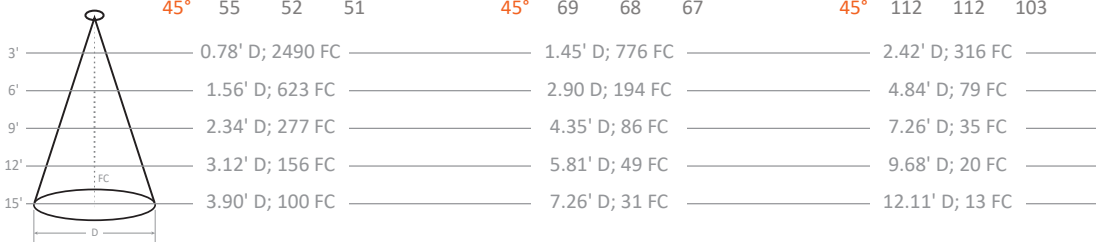

OUTPUT MULTIPLIER

| Package | Optic | Multiplier |
|--------------------------------|-------|------------|
| 18 W 1600 lm Xd24 COB | 15° | 0.80 |
| | 25° | 0.80 |
| | 40° | 0.79 |

CRI-CCT MULTIPLIER

| CRI | CCT | Multiplier |
|------------------|-----------------|------------|
| 8 (80+) | 2200K | 0.86 |
| | 2500K | 0.91 |
| | 2700K | 0.96 |
| | 3000K | 1.00 |
| | 3500K | 1.03 |
| 9 (90+) | 4000K | 1.05 |
| | 2200K | 0.70 |
| | 2500K | 0.77 |
| | 2700K | 0.83 |
| M (MonoWhite) | 3000K | 0.86 |
| | 3500K | 0.88 |
| | V (VioLight) | 3000K |

OUTPUT MULTIPLIER

| Package | Optic | Multiplier |
|----------------------------------------|-------|------------|
| 20 W 1850 lm Xd24 Multi-optic | 15° | 0.70 |
| | 25° | 0.72 |
| | 40° | 0.78 |

| Package | Optic | Multiplier |
|----------------------------------------|-------|------------|
| 28 W 3000 lm Xd24 Multi-optic | 15° | 1.13 |
| | 25° | 1.17 |
| | 40° | 1.12 |

Xd24

MID-HIGH OUTPUT | 3-IN TRACKHEAD FIXTURE

TM30 COLOR REPORTS

- 3000K with 80+ CRI
- $R_f = 84$; $R_g = 94$
- $R_A = 82$; $R_9 = 11$

- 3000K with 90+ CRI
- $R_f = 92$; $R_g = 100$
- $R_A = 93$; $R_9 = 56$

- 3000K with 97+ CRI
- $R_f = 96$; $R_g = 104$
- $R_A = 97$; $R_9 = 98$

- 3000K with MonoWhite
- $R_f = 91$; $R_g = 100$
- $R_A = 91$; $R_9 = 42$

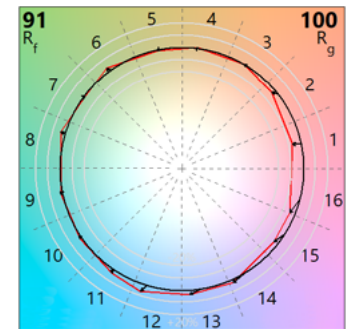
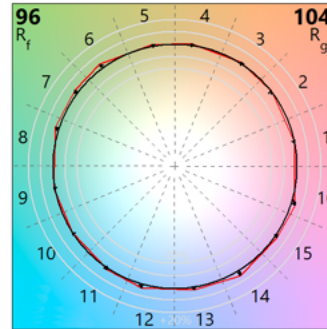
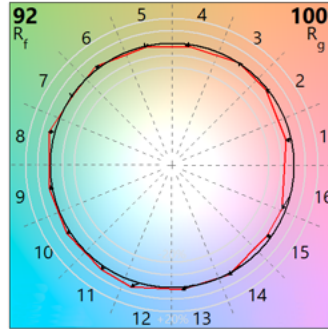
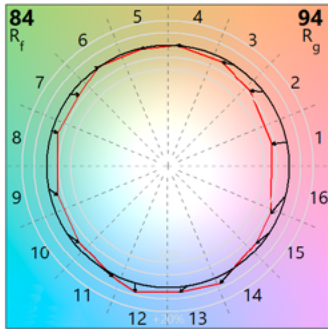
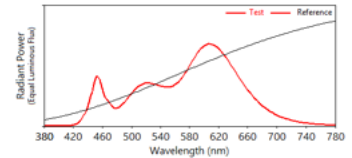
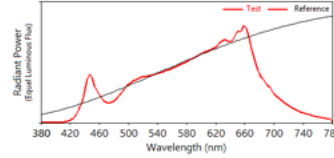
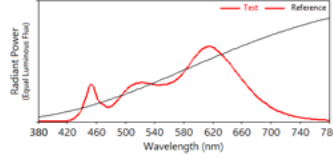
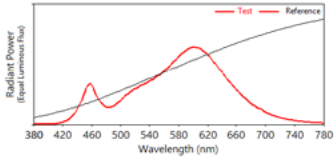

Luxiance utilizes active cooling to remove heat from the LED system - allowing Solais LED lamps to operate cooler, resulting in superior life, light output, and performance.



Thermal Throttle – In the event that Solais products begin to overheat, they will undetectably dim themselves to protect your technology investments.

WARNING: Not for use in fully enclosed luminaires. Risk of electric shock. Use in an indoor, dry location only. This device is not intended for use with emergency exit fixtures or emergency exit lights. May not be compatible with all dimmers; please visit solais.com/dimming for up-to-date dimmer compatibility information.

NOTES: This device complies with Part 15 of the FCC Rule. This product may cause interference with other devices. If interference occurs, change the locations of the products involved. **Compatible on 120v systems.**



VioLight radiates superior quality, enhancing colors in merchandise, making colors more vibrant and offering a truly competitive LED replacement for CMH-like crispness.