

# Xd20

## LOW TO MID OUTPUT | 2.5-IN CANOPY MOUNT FIXTURE

PROJECT \_\_\_\_\_

TYPE \_\_\_\_\_

SPECIFICATION \_\_\_\_\_

- 120 V
  - 50,000 hours (L70)
  - Integrated driver
  - 360° rotation; 0-90° head tilt
  - UL certified for dry locations
  - DesignLights Consortium® Certification (DLC) options
  - RoHS-compliant
  - Power on/off switch on adapters
  - 0-10 V\*, Triac and ELV dimming; compatibility list available
  - VioLight and MonoWhite\* color rendering enhancements available
  - \* 90+ High CRI available.
- To order, replace 'K' in CCT designation with 'h' in code below



Multi-Optic

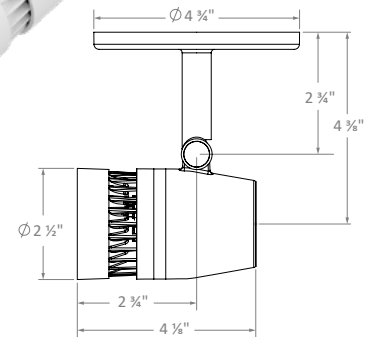

### Ordering Information

Example: Xd20/25m/30K/1450/WH/CM/HL

Fixture	Beam Spread	CCT / Lumens	Housing Color	Mounting	Options
Xd20	COB-optic	25K* / 1000	WH - White	CM* - Canopy Mount	TS - Tapered Snoot HL - Honeycomb Louver SL - Linear Spread SP - Prismatic Spread SS - Solite Spread SF - Frosted Spread 010 - 0-10 V Dimming* EM - Emergency Backup Microinverter* More Accessories Available
	15c	27K / 1050	SV - Silver		
	25c	30K / 1100	BK - Black		
	40c	30m* / 1100	PW* - Perfect White		
	60c	35K* / 1100			
		35m* / 1100			
		40K* / 1100			
		25K* / 1300			
		27K / 1450			
		30K / 1500			
		30m* / 1500			
		35K* / 1500			
		35m* / 1500			
		40K* / 1500			
		25K* / 1800			
		27K / 1900			
		30K / 2000			
		30m* / 2000			
		35K* / 2000			
		35m* / 2000			
	40K* / 2000				
Multi-optic	27K / 1400				
15m	30K / 1450				
25m	30v / 1450				
40m	35K* / 1450				
60m	40K* / 1450				
Specialty	27K / 750				
10c	30K / 750				
Dim-to-Warm	(2700K to 1800K)				
25c	D27 / 1300				
40c					



COB-Optic

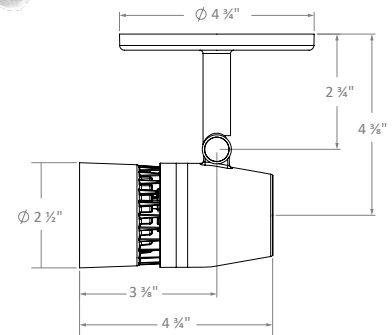

Weight: 17.6 oz.

\*Consult factory for lead time and availability

# Xd20

## LOW TO MID OUTPUT | 2.5-IN CANOPY MOUNT FIXTURE

PROJECT \_\_\_\_\_

TYPE \_\_\_\_\_

SPECIFICATION \_\_\_\_\_

**PHOTOMETRIC DETAILS | baseline X output multiplier X cri-cct multiplier = final output**

COB OPTIC: Baseline for 23 W, 2000 lumens, 80+ CRI, 3000K

**Xd20/10c/30K/750**

Input Power: 11.2 W  
Lumens: 749 lm  
Efficacy: 67 lm/W  
CBCP: 11648  
Beam Angle: 10.6°  
Field Angle: 20.8°  
Spacing Criteria: 0.19

∠	0°	45°	90°
0°	11648	11648	11648
5°	6264	6089	5926
10°	1275	1202	1208
15°	502	487	477
20°	215	210	202
25°	97	96	93
30°	54	56	52
35°	35	34	31
40°	21	20	19
45°	10	9	10

**Xd20/15c/30K/2000**

Input Power: 22.7 W  
Lumens: 1978 lm  
Efficacy: 87 lm/W  
CBCP: 15892  
Beam Angle: 16.2°  
Field Angle: 33.7°  
Spacing Criteria: 0.28

∠	0°	45°	90°
0°	15871	15871	15871
5°	12935	12636	12231
10°	5971	5675	5433
15°	2207	2176	2116
20°	1027	977	936
25°	484	473	436
30°	246	252	230
35°	157	157	146
40°	122	115	109
45°	106	99	88

**Xd20/25c/30K/2000**

Input Power: 22.8 W  
Lumens: 1821 lm  
Efficacy: 80 lm/W  
CBCP: 6729  
Beam Angle: 23.3°  
Field Angle: 50.4°  
Spacing Criteria: 0.41

∠	0°	45°	90°
0°	6729	6729	6729
5°	5937	5855	5779
10°	4081	3975	3895
15°	2348	2291	2231
20°	1274	1228	1203
25°	710	683	676
30°	427	411	404
35°	280	270	265
40°	198	189	187
45°	135	124	124

**Xd20/40c/30K/2000**

Input Power: 22.4 W  
Lumens: 1823 lm  
Efficacy: 81 lm/W  
CBCP: 3312  
Beam Angle: 39.7°  
Field Angle: 72.4°  
Spacing Criteria: 0.72

∠	0°	45°	90°
0°	3310	3310	3310
5°	3180	3206	3216
10°	2795	2843	2868
15°	2227	2283	2320
20°	1591	1636	1682
25°	1021	1047	1095
30°	603	618	655
35°	347	355	378
40°	207	212	224
45°	131	133	140

**Xd20/60c/30K/2000**

Input Power: 22.9 W  
Lumens: 1990 lm  
Efficacy: 87 lm/W  
CBCP: 1121  
Beam Angle: 53.3°  
Field Angle: 91.4°  
Spacing Criteria: 1.00

∠	0°	45°	90°
0°	1118	1118	1118
5°	1089	1085	1076
10°	1030	1018	997
15°	937	922	887
20°	799	770	737
25°	632	598	576
30°	460	431	414
35°	308	287	279
40°	201	187	180
45°	126	117	108

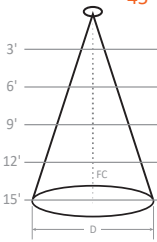

MULTI-OPTIC: Baseline for 16 W, 1450 lumens, 80+ CRI, 3000K

**Xd20/15m/30K/1450**

Input Power: 16.2 W  
Lumens: 1595 lm  
Efficacy: 98 lm/W  
CBCP: 18848  
Beam Angle: 12.7°  
Field Angle: 28.0°  
Spacing Criteria: 0.22

∠	0°	45°	90°
0°	18848	18848	18848
5°	11986	12047	12378
10°	4597	4761	4865
15°	1318	1708	1443
20°	449	521	469
25°	227	262	235
30°	165	172	160
35°	102	112	106
40°	70	76	83
45°	37	34	36

**Xd20/25m/30K/1450**

Input Power: 16.1 W  
Lumens: 1525 lm  
Efficacy: 95 lm/W  
CBCP: 5928  
Beam Angle: 26.1°  
Field Angle: 49.2°  
Spacing Criteria: 0.46

∠	0°	45°	90°
0°	5928	5928	5928
5°	5307	5357	5371
10°	3847	3970	4026
15°	2233	2393	2486
20°	1081	1179	1266
25°	501	554	600
30°	247	278	298
35°	134	152	160
40°	82	89	91
45°	48	54	55

**Xd20/40m/30K/1450**

Input Power: 16.2 W  
Lumens: 1434 lm  
Efficacy: 89 lm/W  
CBCP: 2886  
Beam Angle: 38.2°  
Field Angle: 69.9°  
Spacing Criteria: 0.69

∠	0°	45°	90°
0°	2886	2886	2886
5°	2813	2786	2753
10°	2422	2405	2364
15°	1922	1923	1882
20°	1409	1408	1385
25°	902	915	905
30°	513	532	524
35°	282	292	291
40°	155	161	161
45°	83	84	84

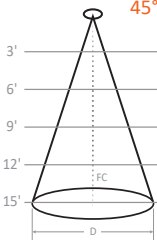

**CRI-CCT MULTIPLIER**

CRI	CCT	Multiplier
8 (80+)	2200K	0.86
	2500K	0.91
	2700K	0.96
	3000K	1.00
	3500K	1.03
9 (90+)	4000K	1.05
	2200K	0.70
	2500K	0.77
	2700K	0.83
M (MonoWhite)	3000K	0.86
	3500K	0.88
	3000K	0.89
V (VioLight)	3000K	0.89

**OUTPUT MULTIPLIER**

Package	Multiplier
17 W 1500 lm Xd20 COB-optic	0.82
13 W 1100 lm Xd20 COB-optic	0.77

## Xd20

### LOW TO MID OUTPUT | 2.5-IN CANOPY MOUNT FIXTURE

PROJECT \_\_\_\_\_

TYPE \_\_\_\_\_

SPECIFICATION \_\_\_\_\_

#### TM30 COLOR REPORTS

- 3000K with 80+ CRI
  - $R_f = 84$ ;  $R_g = 94$
  - $R_A = 82$ ;  $R_9 = 11$
- 3000K with 90+ CRI
  - $R_f = 92$ ;  $R_g = 100$
  - $R_A = 93$ ;  $R_9 = 56$
- 3000K with 97+ CRI
  - $R_f = 96$ ;  $R_g = 104$
  - $R_A = 97$ ;  $R_9 = 98$
- 3000K with MonoWhite
  - $R_f = 91$ ;  $R_g = 100$
  - $R_A = 91$ ;  $R_9 = 42$

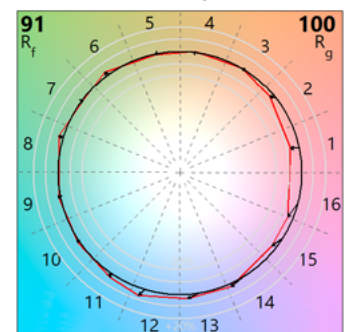
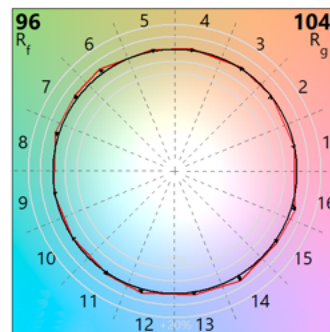
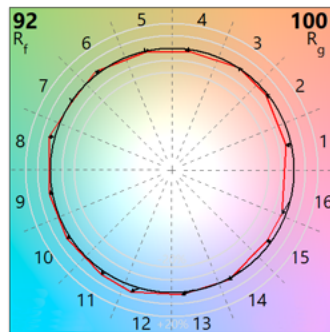
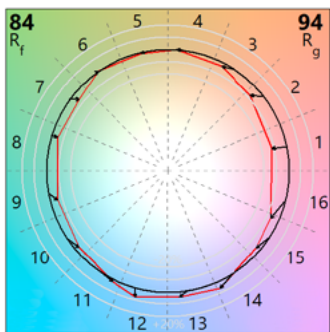
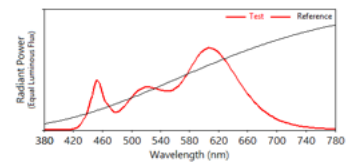
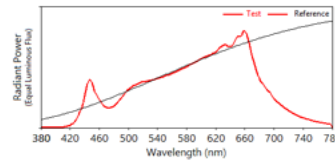
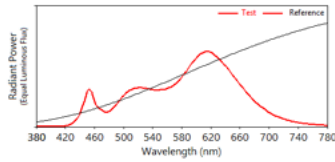
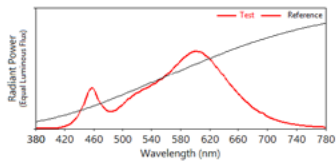

#### DIM TO WARM DETAILS | Dim to warm only available with 25° and 40° beam spreads; 90+ CRI

- 2700K to 1800K with 90+ CRI
  - $R_f = 92$ ;  $R_g = 100$
  - $R_A = 93$ ;  $R_9 = 57$

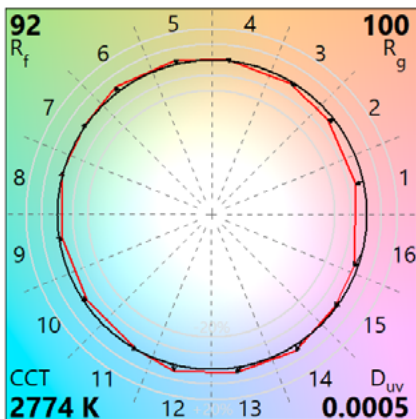
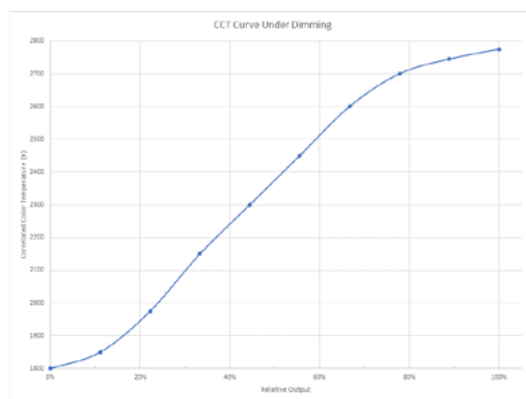
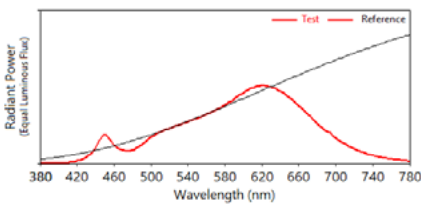

#### Xd20/25c/D27/1300

Input Power: 18.3 W  
 Lumens: 1277 lm  
 Efficacy: 70 lm/W  
 CBCP: 4427  
 Beam Angle: 27.9°  
 Field Angle: 53.1°  
 Spacing Criteria: 0.50

∠	0°	45°	90°
0°	4410	4410	4410
5°	4262	4250	4150
10°	3388	3404	3243
15°	2218	2252	2097
20°	1234	1269	1166
25°	609	624	577
30°	312	314	289
35°	152	151	141
40°	66	69	65
45°	24	26	25

#### Xd20/40c/D27/1300

Input Power: 18.3 W  
 Lumens: 1247 lm  
 Efficacy: 68 lm/W  
 CBCP: 2806  
 Beam Angle: 36.1°  
 Field Angle: 65.9°  
 Spacing Criteria: 0.50

∠	0°	45°	90°
0°	2796	2796	2796
5°	2742	2744	2713
10°	2432	2448	2398
15°	1867	1906	1849
20°	1247	1298	1252
25°	749	787	758
30°	423	443	426
35°	231	241	231
40°	116	122	118
45°	56	59	57

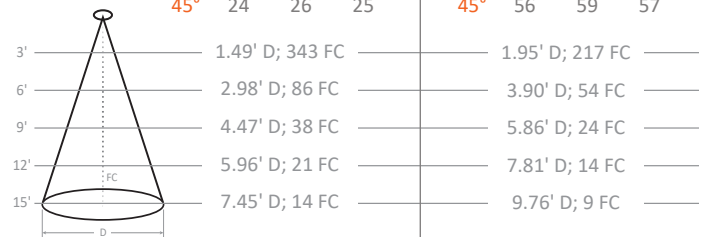

**WARNING:** Not for use in fully enclosed luminaires. Risk of electric shock. Use in an indoor, dry location only. This device is not intended for use with emergency exit fixtures or emergency exit lights. May not be compatible with all dimmers; please visit [solais.com/dimming](http://solais.com/dimming) for up-to-date dimmer compatibility information.  
**NOTES:** This device complies with Part 15 of the FCC Rule. This product may cause interference with other devices. If interference occurs, change the locations of the products involved. **Compatible on 120v systems.**