

# XSR1rm/30

## SUPER-HIGH OUTPUT 1-HEAD ROUND REMODEL

PROJECT \_\_\_\_\_

TYPE \_\_\_\_\_

SPECIFICATION \_\_\_\_\_

- Upgrade to modular Solais multiples without complicated re-installation
- 120 V standard
- Non dimming
- Emergency backup available
- 50,000 Hours (L70)
- UL Certified for dry locations
- RoHS-compliant
- Contains no lead or mercury
- Non-IC rated; insulation must be kept 3" from sides and 1" above housing
- \*VioLight and \*MonoWhite color rendering enhancements available
- \*90+ High CRI available. To order, replace 'K' in CCT designation with 'h' in code below



- Modular Fixture Weight (w/out modules): 7.75 lb
- Ceiling Cut-Out:  $\varnothing$  7 3/4"



### Ordering Information

Example: XSR1rm/Xm30/25c/30K/2300/WH/WH/SL

Fixture	Module	Beam Spread	CCT / Lumens	Options + Accessories	Finish
XSR1rm	Xm30	COB-optic	25K* / 2000	Module Options	Die-cast, Powder Coated
		15c	27K / 2150	HL - Honeycomb Louver	WH / WH - White Module, Interior + Flange
		25c	30K / 2300	SL - Linear Spread	BK / BK - Black Module, Interior + Flange
		40c	30m* / 2300	SP - Prismatic Spread	BK / WH* - Black Module + Interior, White Flange
			35K* / 2300	More Accessories Available	PW / PW* - Perfect White Module, Interior + Flange
			35m* / 2300	Fixture Options	BK / PW* - Black Module + Interior, Perfect White Flange
			40K* / 2300	EM - Emergency Backup	
				Microinverter*	
		18c	25K* / 2800		
		25c	27K / 3135		
		40c	30K / 3300		
		60c	30m* / 3300		
			35K* / 3300		
			35m* / 3300		
			40K* / 3300		
		Multi-optic	27K* / 3500		
		15	30K / 3500		
		25	30v / 3500		
		40	35K* / 3500		
		60	40K* / 3500		
			27K* / 5000		
			30K / 5000		
			35K* / 5000		
			40K* / 5000		

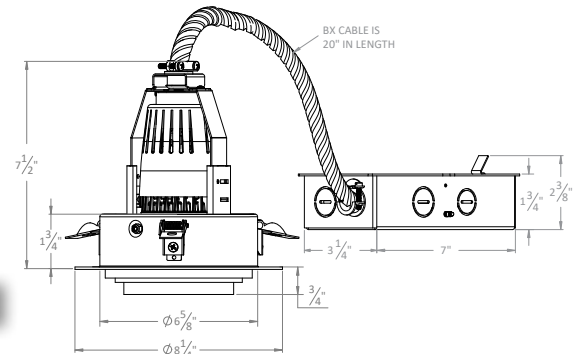

\*Consult factory for lead time and availability

# XSR1rm/30

## SUPER-HIGH OUTPUT 1-HEAD ROUND REMODEL

PROJECT

TYPE

SPECIFICATION

PHOTOMETRIC DETAILS | baseline X output multiplier X cri-cct multiplier = final output

COB OPTIC: Baseline for 36 W,  
3300 lumens, 80+ CRI, 3000K

**Xm30/15c/30K/3300**

Input Power: 36.4 W  
Lumens: 3291 lm  
Efficacy: 91 lm/W  
CBCP: 17300 cd  
Beam Angle: 16.1°  
Field Angle: 33.6°  
Spacing Criteria: 0.28

∠	0°	45°	90°
0°	17300	17300	17300
5°	12927	12605	12670
10°	5898	5641	5689
15°	2283	2214	2214
20°	1029	1006	986
25°	492	476	464
30°	232	225	225
35°	123	122	125
40°	81	80	82
45°	59	58	58

**Xm30/25c/30K/3300**

Input Power: 36.3 W  
Lumens: 3248 lm  
Efficacy: 89 lm/W  
CBCP: 10041 cd  
Beam Angle: 22.3°  
Field Angle: 44.8°  
Spacing Criteria: 0.39

∠	0°	45°	90°
0°	10041	10041	10041
5°	8830	8696	8558
10°	5862	5729	5575
15°	3143	3058	2958
20°	1477	1444	1381
25°	694	678	645
30°	342	334	319
35°	176	174	167
40°	100	100	98
45°	63	63	62

**Xm30/40c/30K/3300**

Input Power: 36.3 W  
Lumens: 3190 lm  
Efficacy: 88 lm/W  
CBCP: 4346 cd  
Beam Angle: 37.2°  
Field Angle: 67.1°  
Spacing Criteria: 0.67

∠	0°	45°	90°
0°	4343	4343	4343
5°	4182	4192	4169
10°	3632	3666	3629
15°	2828	2872	2831
20°	1957	1995	1959
25°	1202	1227	1198
30°	670	679	663
35°	354	358	350
40°	189	192	187
45°	108	110	108

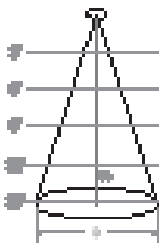

0.85' D; 1346 FC
1.7' D; 336 FC
2.55' D; 150 FC
3.39' D; 84 FC
4.24' D; 54 FC

1.18' D; 781 FC
2.36' D; 195 FC
3.54' D; 87 FC
4.72' D; 49 FC
5.9' D; 31 FC

2.02' D; 338 FC
4.04' D; 84 FC
6.06' D; 38 FC
8.08' D; 21 FC
10.1' D; 14 FC

MULTI-OPTIC: Baseline for 45 W,  
5000 lumens, 80+ CRI, 3000K

**Xm30/15m/30K/5000**

Input Power: 44.9 W  
Lumens: 5136 lm  
Efficacy: 114 lm/W  
CBCP: 45736 cd  
Beam Angle: 16.6°  
Field Angle: 30.5°  
Spacing Criteria: 0.29

∠	0°	45°	90°
0°	45685	45685	45685
5°	37283	35831	34881
10°	17375	16594	15858
15°	5326	4964	4269
20°	1801	1691	1358
25°	804	769	692
30°	471	457	418
35°	293	279	263
40°	221	201	187
45°	160	152	144

**Xm30/25m/30K/5000**

Input Power: 43.8 W  
Lumens: 5077 lm  
Efficacy: 116 lm/W  
CBCP: 27200 cd  
Beam Angle: 22.2°  
Field Angle: 40.6°  
Spacing Criteria: 0.39

∠	0°	45°	90°
0°	27160	27160	27160
5°	24314	22874	22029
10°	16228	14490	13442
15°	7965	6732	6171
20°	3047	2367	2162
25°	1064	875	801
30°	488	442	398
35°	299	278	255
40°	204	192	184
45°	145	142	138

**Xm30/40m/30K/5000**

Input Power: 43.8 W  
Lumens: 4721 lm  
Efficacy: 108 lm/W  
CBCP: 8325 cd  
Beam Angle: 40.8°  
Field Angle: 73.0°  
Spacing Criteria: 0.74

∠	0°	45°	90°
0°	8316	8316	8316
5°	7932	8001	7964
10°	7033	7214	7046
15°	5785	5994	5878
20°	4268	4430	4461
25°	2791	2890	3035
30°	1659	1700	1859
35°	933	956	1079
40°	538	554	626
45°	328	337	366

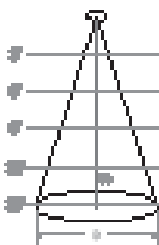

0.87' D; 3553 FC
1.75' D; 888 FC
2.62' D; 395 FC
3.49' D; 222 FC
4.63' D; 142 FC

1.18' D; 2112 FC
2.35' D; 528 FC
3.53' D; 235 FC
4.71' D; 132 FC
5.89' D; 85 FC

2.23' D; 647 FC
4.46' D; 162 FC
6.69' D; 72 FC
8.93' D; 40 FC
11.16' D; 26 FC

OUTPUT MULTIPLIER

Package	Optic	Multiplier
23 W 2300 lm Xm30 COB-optic	15°	0.67
	25°	0.67
	40°	0.67

CRI-CCT MULTIPLIER

CRI	CCT	Multiplier
8 (80+)	2200K	0.86
	2500K	0.91
	2700K	0.96
	3000K	1.00
	3500K	1.03
9	4000K	1.05
	2200K	0.70
	2500K	0.77
	2700K	0.83
M (MonoWhite)	3000K	0.86
	3500K	0.89
	4000K	0.91
V (VioLight)	3000K	0.86
	3500K	0.88

OUTPUT MULTIPLIER

Package	Optic	Multiplier
30 W 3500 lm Xm30 Multi-optic	15°	0.70
	25°	0.70
	40°	0.70

# XSR1rm/30

## SUPER-HIGH OUTPUT 1-HEAD ROUND REMODEL

### TM30 COLOR REPORTS

- 3000K with 80+ CRI
  - $R_f = 84$ ;  $R_g = 94$
  - $R_A = 82$ ;  $R_9 = 11$
- 3000K with 90+ CRI
  - $R_f = 92$ ;  $R_g = 100$
  - $R_A = 93$ ;  $R_9 = 56$
- 3000K with 97+ CRI
  - $R_f = 96$ ;  $R_g = 104$
  - $R_A = 97$ ;  $R_9 = 98$
- 3000K with MonoWhite
  - $R_f = 91$ ;  $R_g = 100$
  - $R_A = 91$ ;  $R_9 = 42$

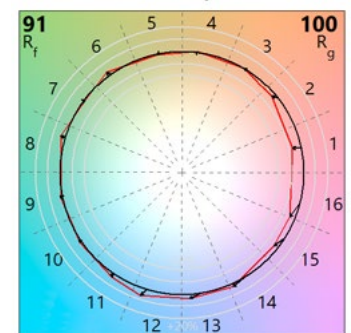
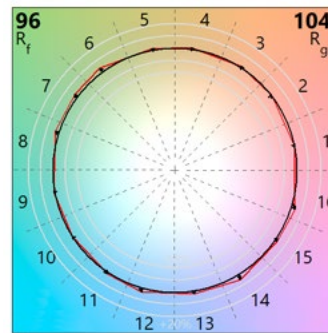
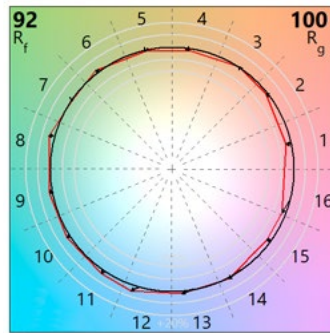
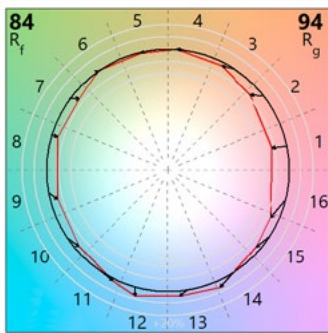
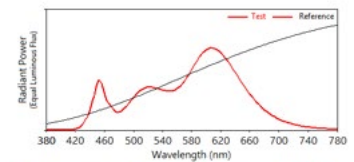
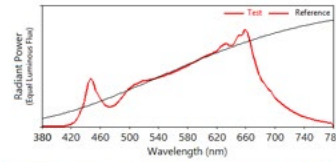
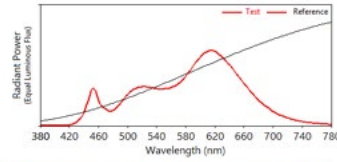
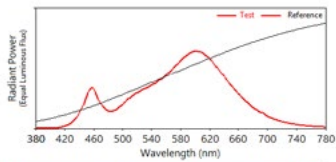

**WARNING:** Not for use in fully enclosed luminaires. Risk of electric shock. Use in an indoor, dry location only. This device is not intended for use with emergency exit fixtures or emergency exit lights. May not be compatible with all dimmers; please visit [solais.com/dimming](http://solais.com/dimming) for up-to-date dimmer compatibility information.

**NOTES:** This device complies with Part 15 of the FCC Rule. This product may cause interference with other devices. If interference occurs, change the locations of the products involved. **Compatible on 120v systems.**



LUXIANCE®

Luxiance utilizes active cooling to remove heat from the LED system - allowing Solais LED lamps to operate cooler, resulting in superior life, light output, and performance.



X-CHANGEABLE

X-Changeable is our all-in-one technology that incorporates the optics, LEDs, driver and power within a replaceable module. This allows you to change the lumen output, color temperature, beam angle and trim color with ease.



THEROTTLER

Thermal Throttle – In the event that Solais products begin to overheat, they will undetectably dim themselves to protect your technology investments.



VIOLIGHT™

VioLight radiates superior quality, enhancing colors in merchandise, making colors more vibrant and offering a truly competitive LED replacement for CMH-like crispness.