

# XS6nc

## X-SERIES | XM30 | 6-INCH SQUARE RECESSED DOWNLIGHT

PROJECT \_\_\_\_\_

TYPE \_\_\_\_\_

SPECIFICATION \_\_\_\_\_

- 120 V standard
- Non-dimming
- Fixed housing for downlight and pinhole; Universal housing for adjustable and wall wash options
- Internally adjustable with dual locking; 360° rotation and 40° aiming
- Field-replaceable LED module with integrated driver; no tools needed
- 50,000 hours (L70)
- RoHs-compliant
- UL listed for dry locations
- Contain no lead or mercury
- Designed for new construction ceiling installation
- Non-IC rated; insulation must be kept 3" from sides and 1" above housing
- VioLight and \*MonoWhite color rendering enhancements available
- \*90+ High CRI available.
- To order, replace 'K' in CCT designation with 'h' in ordering code.



### Ordering Information

Example: XS6nc/D/Xm30/25/30K/3500/BK/WH

Fixture	Type	Module	Beam Spread	CCT / Lumens	Options + Accessories
XS6nc	D - Downlight A - Adjustable WW - Lensed Wall Wash <i>(die-cast only)</i> AS - Adjustable Low Profile	Xm30	COB-optic	25K* / 2000	<b>Options + Accessories</b> HL - Honeycomb Louver SL - Linear Spread SP - Prismatic Spread More Accessories Available Fixture Options  <b>Trim Finish (Cone / Flange)</b> Die-cast, Powder Coated WH / WH - White Cone and Flange BK / WH - Black Cone, White Flange SV / WH - Silver Cone, White Flange BK / BK - Black Cone and Flange SV / SV - Silver Cone and Flange BZ / BZ* - Bronze Cone and Flange BZ / WH* - Bronze Cone, White Flange PW / PW* - Perfect White Cone and Flange BK / PW* - Black Cone, Perfect White Flange SV / PW* - Silver Cone, Perfect White Flange BZ / PW* - Bronze Cone, Perfect White Flange  Lensed Die-cast, Powder Coated <i>(downlight only - polycarbonate soft diffusion lens)</i> WHL / WH - Lensed White Cone and Flange BKL / WH - Lensed Black Cone, White Flange SVL / WH - Lensed Silver Cone, White Flange BKL / BK - Lensed Black Cone and Flange SVL / SV - Lensed Silver Cone and Flange BZL / BZ* - Lensed Bronze Cone and Flange BZL / WH* - Lensed Bronze Cone, White Flange PWL / PW* - Lensed White Cone and Flange BKL / PW* - Lensed Black Cone, White Flange SVL / PW* - Lensed Silver Cone, White Flange BZL / PW* - Lensed Bronze Cone, White Flange
			15c	27K / 2150	
			25c	30K / 2300	
			40c	30m* / 2300	
				35K* / 2300	
				35m* / 2300	
				40K* / 2300	
			18c	25K* / 2800	
			25c	27K / 3135	
			40c	30K / 3300	
			60c	30m* / 3300	
				35K* / 3300	
		35m* / 3300			
		40K* / 3300			
	Multi-optic	27K* / 3500			
	15	30K / 3500			
	25	30v / 3500			
	40	35K* / 3500			
	60	40K* / 3500			
		27K* / 5000			
		30K / 5000			
		35K* / 5000			
		40K* / 5000			

\*Consult factory for lead time and availability

Notes: Modules are black finish standard. Other finishes are available; consult factory for custom specification.

60c/60° Beam Spread is achieved with 25c/25° optic and WT trim accessory; not available for adjustable trims.

# XS6nc

X-SERIES | XM30 | 6-INCH  
SQUARE RECESSED DOWNLIGHT

PROJECT \_\_\_\_\_

TYPE \_\_\_\_\_

SPECIFICATION \_\_\_\_\_

▪ UNIVERSAL HOUSING

▪ TRIM WITH INTEGRAL FLANGE

Fixture Height: 9 1/2"  
Max Ceiling Thickness: 5/8" Standard; Other Options\*  
Ceiling Cut-Out: 7 1/2" Square  
Weight without module: 8.6 lb

▪ AIMING

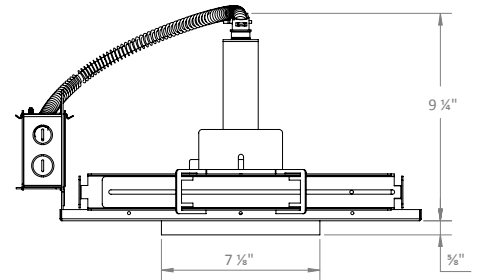
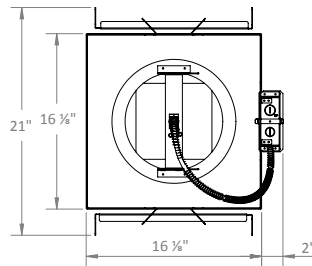
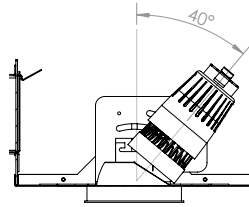

▪ FIXED HOUSING

▪ TRIM WITH INTEGRAL FLANGE

Fixture Height: 9 3/8"  
Max Ceiling Thickness: 5/8" Standard; Other Options\*  
Ceiling Cut-Out: 7 1/2" Square  
Weight without module: 8.2 lb

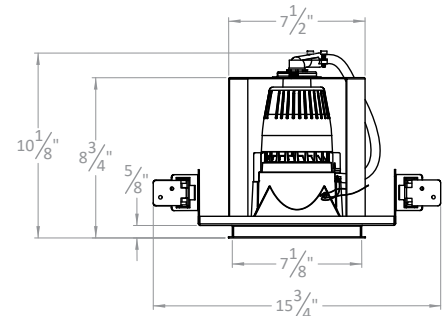
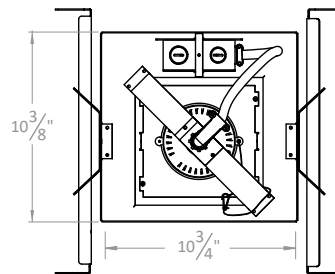
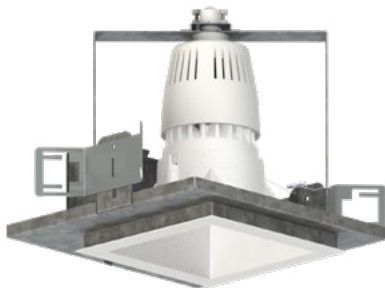

# XS6nc

## X-SERIES | XM30 | 6-INCH SQUARE RECESSED DOWNLIGHT

PROJECT \_\_\_\_\_

TYPE \_\_\_\_\_

SPECIFICATION \_\_\_\_\_

**PHOTOMETRIC DETAILS | baseline X output multiplier X cri-cct multiplier = final output**

COB OPTIC: Baseline for 36 W,  
3300 lumens, 80+ CRI, 3000K

**Xm30/15c/30K/3300**

Input Power: 36.4 W  
Lumens: 3291 lm  
Efficacy: 91 lm/W  
CBCP: 17300 cd  
Beam Angle: 16.1°  
Field Angle: 33.6°  
Spacing Criteria: 0.28

∠	0°	45°	90°
0°	17300	17300	17300
5°	12927	12605	12670
10°	5898	5641	5689
15°	2283	2214	2214
20°	1029	1006	986
25°	492	476	464
30°	232	225	225
35°	123	122	125
40°	81	80	82
45°	59	58	58

**Xm30/25c/30K/3300**

Input Power: 36.3 W  
Lumens: 3248 lm  
Efficacy: 89 lm/W  
CBCP: 10041 cd  
Beam Angle: 22.3°  
Field Angle: 44.8°  
Spacing Criteria: 0.39

∠	0°	45°	90°
0°	10041	10041	10041
5°	8830	8696	8558
10°	5862	5729	5575
15°	3143	3058	2958
20°	1477	1444	1381
25°	694	678	645
30°	342	334	319
35°	176	174	167
40°	100	100	98
45°	63	63	62

**Xm30/40c/30K/3300**

Input Power: 36.3 W  
Lumens: 3190 lm  
Efficacy: 88 lm/W  
CBCP: 4346 cd  
Beam Angle: 37.2°  
Field Angle: 67.1°  
Spacing Criteria: 0.67

∠	0°	45°	90°
0°	4343	4343	4343
5°	4182	4192	4169
10°	3632	3666	3629
15°	2828	2872	2831
20°	1957	1995	1959
25°	1202	1227	1198
30°	670	679	663
35°	354	358	350
40°	189	192	187
45°	108	110	108

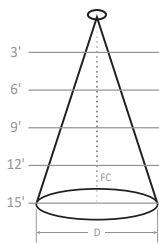

Height	Diameter (D)	Foot-Candle (FC)
3'	1.18' D	781 FC
6'	2.36' D	195 FC
9'	3.54' D	87 FC
12'	4.72' D	49 FC
15'	5.9' D	31 FC

Height	Diameter (D)	Foot-Candle (FC)
3'	2.02' D	338 FC
6'	4.04' D	84 FC
9'	6.06' D	38 FC
12'	8.08' D	21 FC
15'	10.1' D	14 FC

MULTI-OPTIC: Baseline for 45 W,  
5000 lumens, 80+ CRI, 3000K

**Xm30/15m/30K/5000**

Input Power: 44.9 W  
Lumens: 5136 lm  
Efficacy: 114 lm/W  
CBCP: 45736 cd  
Beam Angle: 16.6°  
Field Angle: 30.5°  
Spacing Criteria: 0.29

∠	0°	45°	90°
0°	45685	45685	45685
5°	37283	35831	34881
10°	17375	16594	15858
15°	5326	4964	4269
20°	1801	1691	1358
25°	804	769	692
30°	471	457	418
35°	293	279	263
40°	221	201	187
45°	160	152	144

**Xm30/25m/30K/5000**

Input Power: 43.8 W  
Lumens: 5077 lm  
Efficacy: 116 lm/W  
CBCP: 27200 cd  
Beam Angle: 22.2°  
Field Angle: 40.6°  
Spacing Criteria: 0.39

∠	0°	45°	90°
0°	27160	27160	27160
5°	24314	22874	22029
10°	16228	14490	13442
15°	7965	6732	6171
20°	3047	2367	2162
25°	1064	875	801
30°	488	442	398
35°	299	278	255
40°	204	192	184
45°	145	142	138

**Xm30/40m/30K/5000**

Input Power: 43.8 W  
Lumens: 4721 lm  
Efficacy: 108 lm/W  
CBCP: 8325 cd  
Beam Angle: 40.8°  
Field Angle: 73.0°  
Spacing Criteria: 0.74

∠	0°	45°	90°
0°	8316	8316	8316
5°	7932	8001	7964
10°	7033	7214	7046
15°	5785	5994	5878
20°	4268	4430	4461
25°	2791	2890	3035
30°	1659	1700	1859
35°	933	956	1079
40°	538	554	626
45°	328	337	366

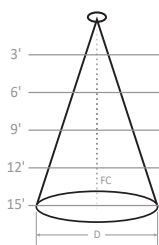

Height	Diameter (D)	Foot-Candle (FC)
3'	1.18' D	2112 FC
6'	2.35' D	528 FC
9'	3.53' D	235 FC
12'	4.71' D	132 FC
15'	5.89' D	85 FC

Height	Diameter (D)	Foot-Candle (FC)
3'	2.23' D	647 FC
6'	4.46' D	162 FC
9'	6.69' D	72 FC
12'	8.93' D	40 FC
15'	11.16' D	26 FC

**OUTPUT MULTIPLIER**

Package	Optic	Multiplier
23 W 2300 lm Xm30 COB-optic	15°	0.67
	25°	0.67
	40°	0.67

**CRI-CCT MULTIPLIER**

CRI	CCT	Multiplier	
8 (80+)	2200K	0.86	
	2500K	0.91	
	2700K	0.96	
	3000K	1.00	
	3500K	1.03	
9	4000K	1.05	
	M (MonoWhite)	2200K	0.70
		2500K	0.77
		2700K	0.83
		3000K	0.86
3500K		0.89	
V (VioLight)	4000K	0.91	
	3000K	0.86	
V (VioLight)	3500K	0.88	
	3000K	0.89	

**OUTPUT MULTIPLIER**

Package	Optic	Multiplier
30 W 3500 lm Xm30 Multi-optic	15°	0.70
	25°	0.70
	40°	0.70

# XS6nc

## X-SERIES | XM30 | 6-INCH SQUARE RECESSED DOWNLIGHT

PROJECT \_\_\_\_\_

TYPE \_\_\_\_\_

SPECIFICATION \_\_\_\_\_

### TM30 COLOR REPORTS

- 3000K with 80+ CRI
- $R_f = 84$ ;  $R_g = 94$
- $R_A = 82$ ;  $R_9 = 11$

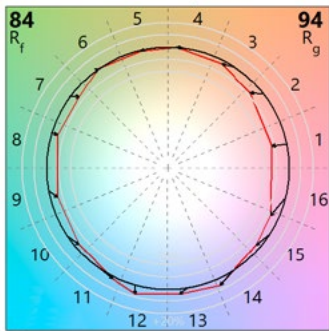
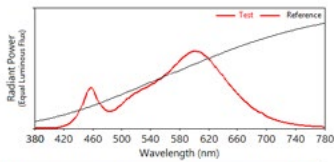

- 3000K with 90+ CRI
- $R_f = 92$ ;  $R_g = 100$
- $R_A = 93$ ;  $R_9 = 56$

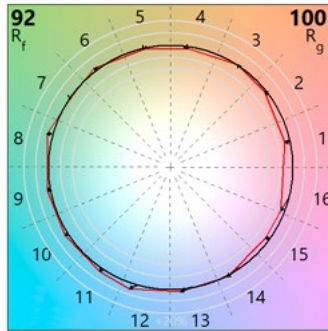
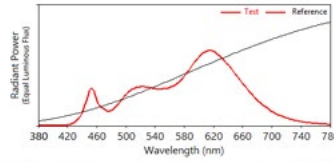

- 3000K with 97+ CRI
- $R_f = 96$ ;  $R_g = 104$
- $R_A = 97$ ;  $R_9 = 98$

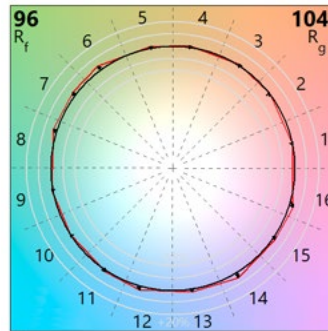
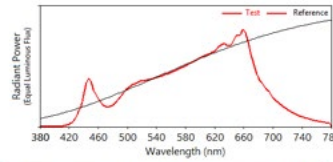

- 3000K with MonoWhite
- $R_f = 91$ ;  $R_g = 100$
- $R_A = 91$ ;  $R_9 = 42$

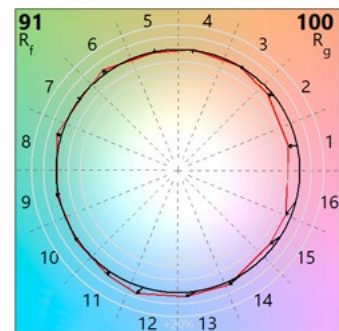
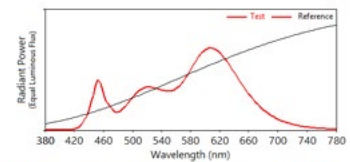

**WARNING:** Not for use in fully enclosed luminaires. Risk of electric shock. Use in an indoor, dry location only. This device is not intended for use with emergency exit fixtures or emergency exit lights. May not be compatible with all dimmers; please visit [solais.com/dimming](http://solais.com/dimming) for up-to-date dimmer compatibility information.  
**NOTES:** This device complies with Part 15 of the FCC Rule. This product may cause interference with other devices. If interference occurs, change the locations of the products involved. **Compatible on 120v systems.**



Luxiance utilizes active cooling to remove heat from the LED system - allowing Solais LED lamps to operate cooler, resulting in superior life, light output, and performance.



X-CHANGEABLE

X-Changeable is our all-in-one technology that incorporates the optics, LEDs, driver and power within a replaceable module. This allows you to change the lumen output, color temperature, beam angle and trim color with ease.



THEROTTLE

Thermal Throttle – In the event that Solais products begin to overheat, they will undetectably dim themselves to protect your technology investments.



VIOLIGHT™

VioLight radiates superior quality, enhancing colors in merchandise, making colors more vibrant and offering a truly competitive LED replacement for CMH-like crispness.