

XS4nc

X-SERIES | XM24 | 4-INCH SQUARE RECESSED DOWNLIGHT

PROJECT _____

TYPE _____

SPECIFICATION _____

- 120 V standard
- 0-10 V*, Triac and ELV dimming
- Fixed housing for downlight and pinhole; Universal housing for adjustable and wall wash options
- Internally adjustable with dual locking; 360° rotation and 40° aiming
- Field-replaceable LED module with integrated driver; no tools needed
- 50,000 hours (L70)
- RoHs-compliant
- UL Certified for dry locations
- Contain no lead or mercury
- Designed for new construction ceiling installation
- Non-IC rated; insulation must be kept 3" from sides and 1" above housing
- VioLight and *MonoWhite color rendering enhancements available
- *90+ High CRI available.
- To order, replace 'K' in CCT designation with 'h' in ordering code.



Ordering Information

Example: XS4nc/D/Xm24/25/30K/2400/BK/WH

Fixture	Type	Module	Beam Spread	CCT / Lumens	Options + Module Accessories
XS4nc	D - Downlight A - Adjustable P - Pinhole <i>(downlight and die-cast with flange only)</i> WW - Lensed Wall Wash <i>(die-cast with flange only)</i> AS - Adjustable Shallow Trim	Xm24	COB-optic 15c 25c 40c 60c Multi-optic 15 25 40 60	25K* / 1400 27K / 1550 30K / 1600 30m* / 1600 35K* / 1600 35m* / 1600 40K* / 1600 30v / 1850 27K / 2300 30K / 2400 35K* / 2400 40K* / 2400 27K / 3000 30K / 3000 35K* / 3000 40K* / 3000	HL - Honeycomb Louver SL - Linear Spread SP - Prismatic Spread More Accessories Available Fixture Options 010 - 0-10 V Dimming* Trim Finish (Cone / Flange) Die-cast, Powder Coated WH / WH - White Cone and Flange BK / WH - Black Cone, White Flange SV / WH - Silver Cone, White Flange BK / BK - Black Cone and Flange SV / SV - Silver Cone and Flange BZ / BZ* - Bronze Cone and Flange BZ / WH* - Bronze Cone, White Flange PW / PW* - Perfect White Cone and Flange BK / PW* - Black Cone, Perfect White Flange SV / PW* - Silver Cone, Perfect White Flange BZ / PW* - Bronze Cone, Perfect White Flange Lensed Die-cast, Powder Coated <i>(downlight only - polycarbonate soft diffusion lens)</i> WHL / WH - Lensed White Cone and Flange BKL / WH - Lensed Black Cone, White Flange SVL / WH - Lensed Silver Cone, White Flange BKL / BK - Lensed Black Cone and Flange SVL / SV - Lensed Silver Cone and Flange BZL / BZ* - Lensed Bronze Cone and Flange BZL / WH* - Lensed Bronze Cone, White Flange PWL / PW* - Lensed White Cone and Flange BKL / PW* - Lensed Black Cone, White Flange SVL / PW* - Lensed Silver Cone, White Flange BZL / PW* - Lensed Bronze Cone, White Flange

*Consult factory for lead time and availability

Notes: Modules are black finish standard. Other finishes are available; consult factory for custom specification.

60c Beam Spread is achieved with 25c optic and WT trim accessories; not available for adjustable trims.

XS4nc

X-SERIES | XM24 | 4-INCH
SQUARE RECESSED DOWNLIGHT

PROJECT _____

TYPE _____

SPECIFICATION _____

▪ UNIVERSAL HOUSING

▪ TRIM WITH INTEGRAL FLANGE

Fixture Height: 8"
Max Ceiling Thickness: 5/8" Standard; Other Options*
Ceiling Cut-Out: 5 1/3" Square
Weight without module: 7.41 lb

▪ AIMING

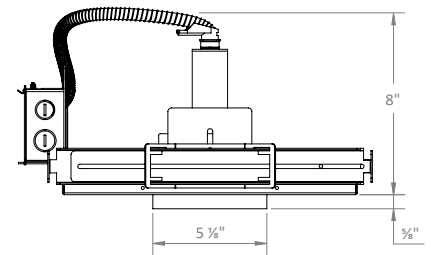
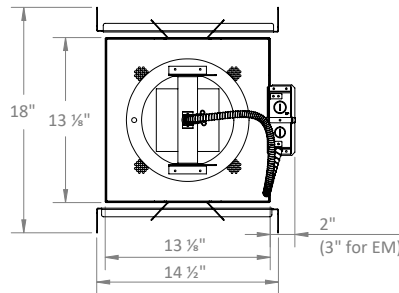
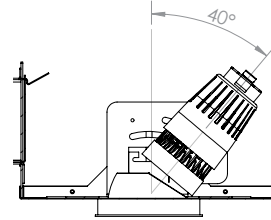

▪ FIXED HOUSING

▪ TRIM WITH INTEGRAL FLANGE

Fixture Height: 8"
Max Ceiling Thickness: 5/8" Standard; Other Options*
Ceiling Cut-Out: 5 1/3" Square
Weight without module: 7 lb

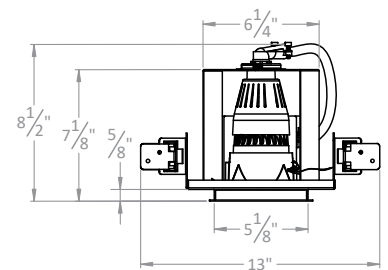
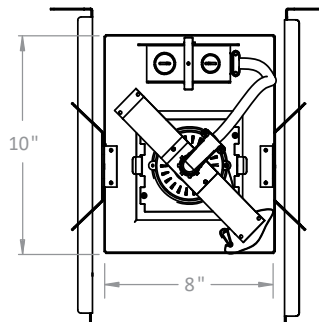
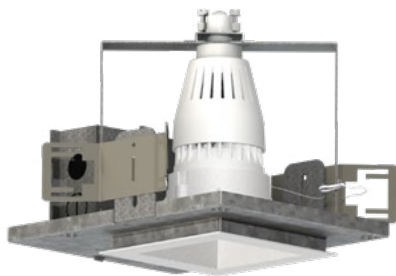

XS4nc

X-SERIES | XM24 | 4-INCH SQUARE RECESSED DOWNLIGHT

PROJECT _____

TYPE _____

SPECIFICATION _____

PHOTOMETRIC DETAILS | baseline X output multiplier X cri-cct multiplier = final output

COB OPTIC: Baseline data for 22 W, 2000 lumens, 80+ CRI, 3000K

Xm24/15c/30K/2000

Input Power:	22.5 W
Lumens:	1868 lm
Efficacy:	82.9 lm/W
Beam Angle:	19.2°
Field Angle:	49.1°

∠	0°	45°	90°
0°	7831	7831	7831
5°	6438	6425	6339
10°	3671	3628	3524
15°	1830	1823	1789
20°	1088	1090	1069
25°	726	736	709
30°	501	516	496
35°	342	353	344
40°	233	238	236
45°	157	160	163

Xm24/25c/30K/2000

Input Power:	21.9 W
Lumens:	2200 lm
Efficacy:	100.3 lm/W
Beam Angle:	23.9°
Field Angle:	59.8°

∠	0°	45°	90°
0°	6529	6529	6529
5°	5797	5759	5621
10°	4014	3962	3803
15°	2347	2286	2202
20°	1369	1344	1311
25°	904	894	874
30°	646	642	628
35°	458	465	453
40°	332	341	331
45°	241	250	242

Xm24/40c/30K/2000

Input Power:	22.2 W
Lumens:	2013 lm
Efficacy:	90.9 lm/W
Beam Angle:	38.8°
Field Angle:	85.9°

∠	0°	45°	90°
0°	3023	3023	3023
5°	2893	2871	2848
10°	2530	2476	2437
15°	2026	1961	1911
20°	1511	1447	1402
25°	1073	1023	987
30°	749	716	690
35°	527	507	491
40°	380	368	357
45°	278	271	263

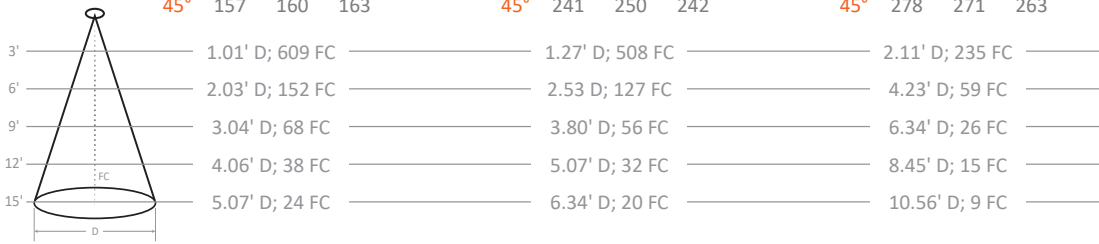

OUTPUT MULTIPLIER

Package	Optic	Multiplier
18 W 1600 lm Xm24 COB	15°	0.80
	25°	0.80
	40°	0.79

CRI-CCT MULTIPLIER

CRI	CCT	Multiplier
80 (80+)	2200K	0.86
	2500K	0.91
	2700K	0.96
	3000K	1.00
	3500K	1.03
90 (90+)	4000K	1.05
	2200K	0.70
	2500K	0.77
	2700K	0.83
M (MonoWhite)	3000K	0.86
	3500K	0.89
	4000K	0.91
V (VioLight)	3000K	0.88

MULTI-OPTIC: Baseline data for 26 W, 2400 lumens, 80+ CRI, 3000K

Xm24/15/30K/2400

Input Power:	26.4 W
Lumens:	2636 lm
Efficacy:	100.0 lm/W
Beam Angle:	14.8°
Field Angle:	26.1°

∠	0°	45°	90°
0°	32012	32012	32012
5°	23079	22740	22414
10°	7807	8170	8147
15°	1905	1732	1527
20°	642	512	463
25°	268	253	255
30°	157	151	150
35°	99	91	89
40°	72	66	62
45°	55	52	51

Xm24/25/30K/2400

Input Power:	26.4 W
Lumens:	2573 lm
Efficacy:	97.4 lm/W
Beam Angle:	27.2°
Field Angle:	48.4°

∠	0°	45°	90°
0°	9977	9977	9977
5°	9134	9161	9195
10°	6880	6928	6963
15°	4125	4130	4112
20°	1967	1951	1931
25°	824	797	783
30°	367	340	323
35°	191	172	164
40°	111	103	99
45°	69	68	67

Xm24/40/30K/2400

Input Power:	26.4 W
Lumens:	2385 lm
Efficacy:	90.5 lm/W
Beam Angle:	44.0°
Field Angle:	71.7°

∠	0°	45°	90°
0°	4057	4057	4057
5°	4083	3943	3829
10°	3913	3706	3506
15°	3452	3328	3021
20°	2599	2596	2302
25°	1651	1710	1532
30°	913	969	889
35°	456	488	459
40°	221	238	225
45°	112	112	103

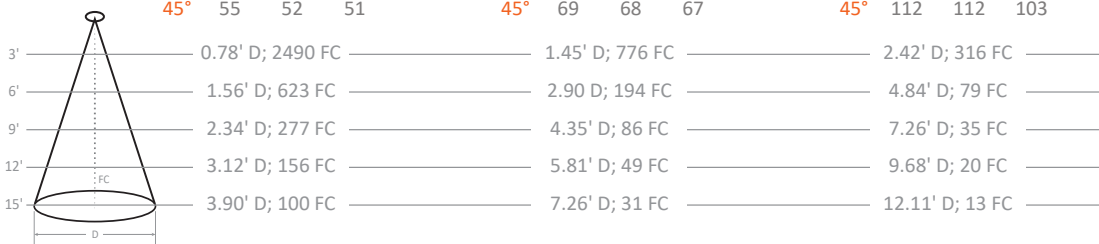

OUTPUT MULTIPLIER

Package	Optic	Multiplier
20 W 1850 lm Xm24 Multi-optic	15°	0.70
	25°	0.72
	40°	0.78

Package	Optic	Multiplier
28 W 3000 lm Xm24 Multi-optic	15°	1.13
	25°	1.17
	40°	1.12

XS4nc

X-SERIES | XM24 | 4-INCH SQUARE RECESSED DOWNLIGHT

TM30 COLOR REPORTS

- 3000K with 80+ CRI
 - $R_f = 84$; $R_g = 94$
 - $R_A = 82$; $R_g = 11$
- 3000K with 90+ CRI
 - $R_f = 92$; $R_g = 100$
 - $R_A = 93$; $R_g = 56$
- 3000K with 97+ CRI
 - $R_f = 96$; $R_g = 104$
 - $R_A = 97$; $R_g = 98$
- 3000K with MonoWhite
 - $R_f = 91$; $R_g = 100$
 - $R_A = 91$; $R_g = 42$

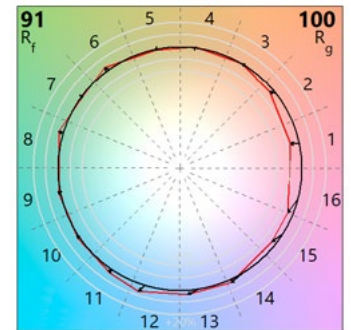
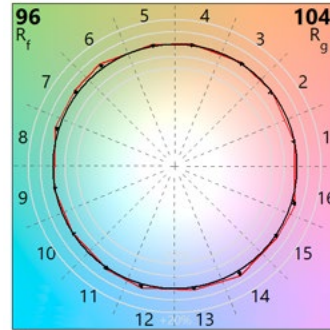
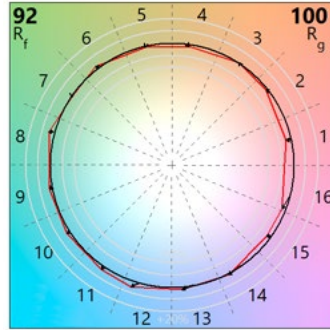
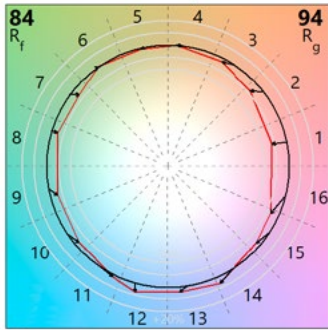
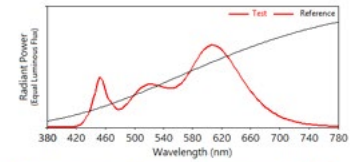
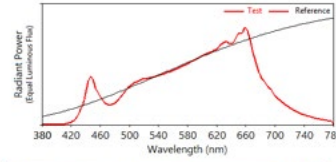
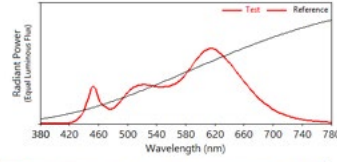
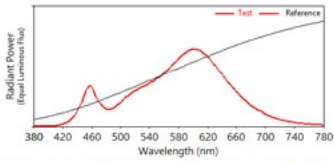

WARNING: Not for use in fully enclosed luminaires. Risk of electric shock. Use in an indoor, dry location only. This device is not intended for use with emergency exit fixtures or emergency exit lights. May not be compatible with all dimmers; please visit solais.com/dimming for up-to-date dimmer compatibility information.

NOTES: This device complies with Part 15 of the FCC Rule. This product may cause interference with other devices. If interference occurs, change the locations of the products involved. **Compatible on 120v systems.**



Luxiance utilizes active cooling to remove heat from the LED system - allowing Solais LED lamps to operate cooler, resulting in superior life, light output, and performance.



X-Changeable is our all-in-one technology that incorporates the optics, LEDs, driver and power within a replaceable module. This allows you to change the lumen output, color temperature, beam angle and trim color with ease.



Thermal Throttle – In the event that Solais products begin to overheat, they will undetectably dim themselves to protect your technology investments.



VioLight radiates superior quality, enhancing colors in merchandise, making colors more vibrant and offering a truly competitive LED replacement for CMH-like crispness.