

- 120 V
- 0-10 V*, Triac and ELV dimming
- Integrated driver
- Actively cooled fixtures
- 2 self-locking aiming height positions
- 0-50° vertical tilt; 360° rotation
- Modular individually specifiable optics
- 50,000 hours (L70)
- RoHS-compliant
- Dry location rating
- Certified to UL standards for dry locations
- Rated for IC and non-IC use
- Designed for new construction ceilings only
- VioLight and *MonoWhite color rendering enhancements available
- *90+ High CRI available.
To order, replace 'K' in CCT designation with 'h' in ordering code.
- Aiming

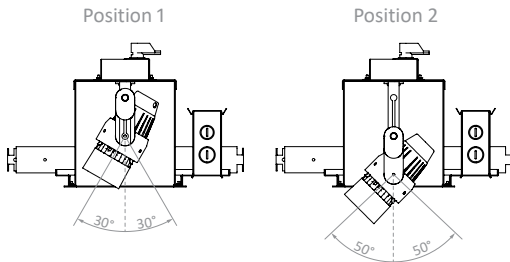

- Modular Fixture Weight (without modules): 7.25 lb
- Ceiling Cut-Out: 7 3/8" x 7 3/8"

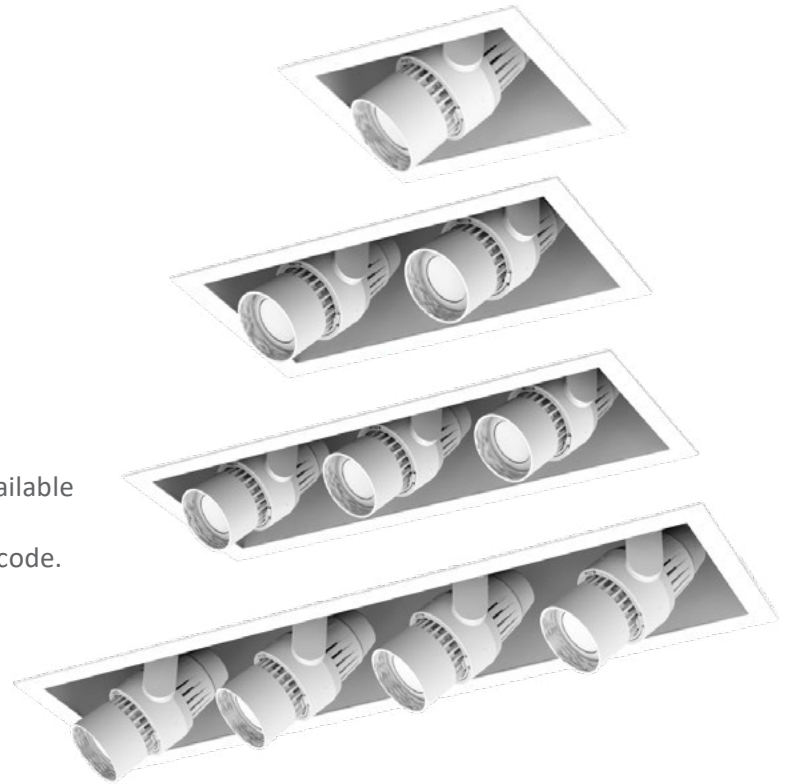
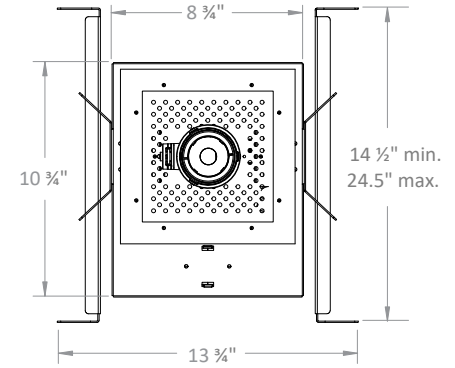
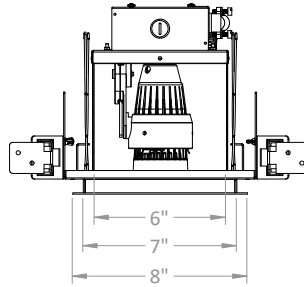

Ordering Information

Example: XAR11/Xm20/25c/30K/1000/WH/WH/SL

Fixture	Module	Beam Spread	CCT / Lumens	Options + Accessories
XAR11	Xm20	COB-optic	25K* / 1000	Module Options HL - Honeycomb Louver SL - Linear Spread SP - Prismatic Spread SS - Solite Spread SF - Frosted Spread More Accessories Available Fixture Options 010 - 0-10 V Dimming*
		15c	27K / 1050	
		25c	30K / 1100	
		40c	30m* / 1100	
		60c	35K* / 1100	
			35m* / 1100	
			40K* / 1100	
			25K* / 1300	
			27K / 1450	
			30K / 1500	
			30m* / 1500	
			35K* / 1500	
			35m* / 1500	
			40K* / 1500	
			25K* / 1800	
			27K / 1900	
			30K / 2000	
			30m* / 2000	
			35K* / 2000	
			35m* / 2000	
			40K* / 2000	
		Multi-optic	27K / 1400	
		15m	30K / 1450	
		25m	30v / 1450	
		40m	35K* / 1450	
		60m	40K* / 1450	
		Specialty	27K / 750	
		10c	30K / 750	
		Dim-to-Warm	(2700K to 1800K)	
		25c	D27 / 1300	
		40c		

Finish

- Die-cast, Powder Coated
- WH / WH - White Module, Interior + Flange
- BK / BK - Black Module, Interior + Flange
- BK / WH* - Black Module + Interior, White Flange
- PW / PW* - Perfect White Module, Interior + Flange
- BK / PW* - Black Module + Interior, Perfect White Flange

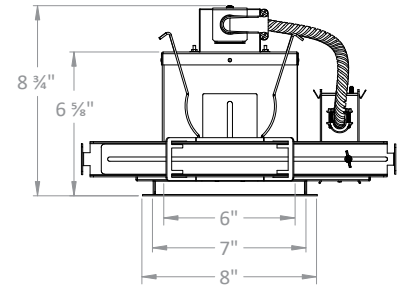

*Consult factory for lead time and availability

- Modular Fixture Weight (without modules): 11 lb
- Ceiling Cut-Out: 7 3/8" x 13 3/8"

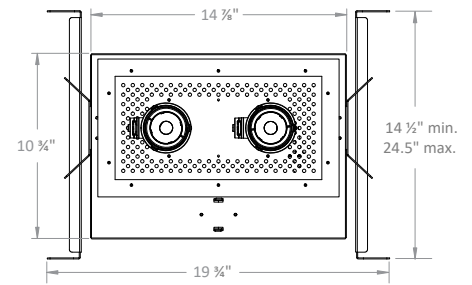
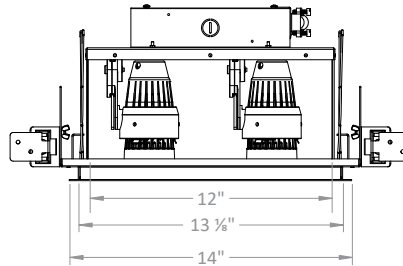

Ordering Information

Example: XAR12/Xm20/25m-25m/30K/1100/WH/WH/SL-SL

Fixture	Module	Beam Spread	CCT / Lumens	Options + Accessories
XAR12	Xm20	COB-optic	25K* / 1000	Module Options
		15c	27K / 1050	HL - Honeycomb Louver
		25c	30K / 1100	SL - Linear Spread
		40c	30m* / 1100	SP - Prismatic Spread
		60c	35K* / 1100	SS - Solite Spread
			35m* / 1100	SF - Frosted Spread
			40K* / 1100	More Accessories Available
			25K* / 1300	Fixture Options
			27K / 1450	010 - 0-10 V Dimming*
			30K / 1500	
			30m* / 1500	
			35K* / 1500	
			35m* / 1500	
			40K* / 1500	
			25K* / 1800	
			27K / 1900	
			30K / 2000	
			30m* / 2000	
			35K* / 2000	
			35m* / 2000	
			40K* / 2000	
		Multi-optic	27K / 1400	
		15m	30K / 1450	
		25m	30v / 1450	
		40m	35K* / 1450	
		60m	40K* / 1450	
		Specialty	27K / 750	
		10c	30K / 750	
		Dim-to-Warm	(2700K to 1800K)	
		25c	D27 / 1300	
		40c		

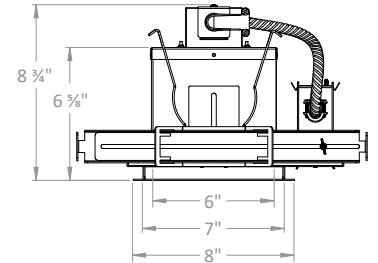

Finish

Die-cast, Powder Coated
 WH / WH - White Module, Interior + Flange
 BK / BK - Black Module, Interior + Flange
 BK / WH* - Black Module + Interior, White Flange
 PW / PW* - Perfect White Module, Interior + Flange
 BK / PW* - Black Module + Interior, Perfect White Flange

*Consult factory for lead time and availability

- Modular Fixture Weight (without modules): 12.5
- Ceiling Cut-Out: 7 3/8" x 19 3/8"

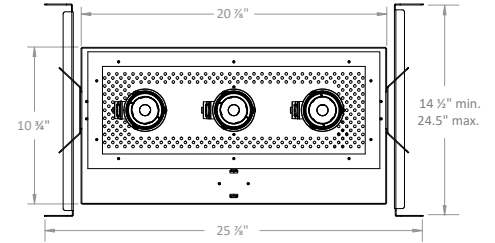
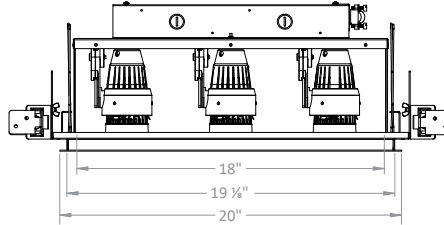

Ordering Information

Example: XAR13/Xm20/25c-25c-25c/30K/1100/WH/WH/SL-SL-SL

1 - 2 - 3				1 - 2 - 3	
Fixture	Module	Beam Spread	CCT / Lumens	Options + Accessories	
XAR13	Xm20	COB-optic	25K* / 1000	Module Options	
		15c	27K / 1050	HL - Honeycomb Louver	
		25c	30K / 1100	SL - Linear Spread	
		40c	30m* / 1100	SP - Prismatic Spread	
		60c	35K* / 1100	SS - Solite Spread	
			35m* / 1100	SF - Frosted Spread	
			40K* / 1100	More Accessories Available	
			25K* / 1300	Fixture Options	
			27K / 1450	010 - 0-10 V Dimming*	
			30K / 1500		
			30m* / 1500		
			35K* / 1500		
			35m* / 1500		
			40K* / 1500		
			25K* / 1800		
			27K / 1900		
			30K / 2000		
			30m* / 2000		
			35K* / 2000		
			35m* / 2000		
			40K* / 2000		
		Multi-optic	27K / 1400		
		15m	30K / 1450		
		25m	30v / 1450		
		40m	35K* / 1450		
		60m	40K* / 1450		
		Specialty	27K / 750		
		10c	30K / 750		
		Dim-to-Warm	(2700K to 1800K)		
		25c	D27 / 1300		
		40c			

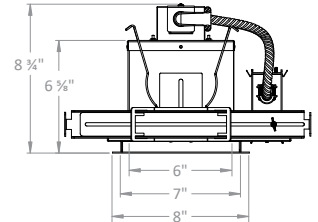

*Consult factory for lead time and availability

- Modular Fixture Weight (without modules): 14.75 lb
- Ceiling Cut-Out: 7 3/8" x 25 1/2"

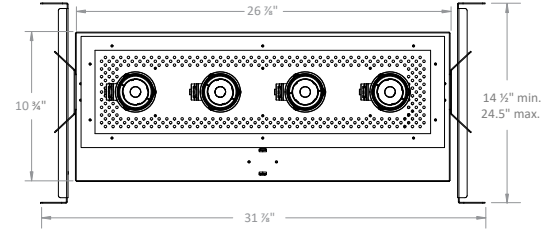
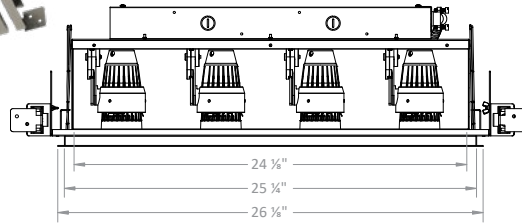

Ordering Information

Example: XAR14/Xm20/25c-25c-25c-25c/30K/1100/WH/WH/SL-SL-SL-SL

1 - 2 - 3 - 4 1 - 2 - 3 - 4

Fixture	Module	Beam Spread	CCT / Lumens	Options + Accessories
XAR14	Xm20	COB-optic	25K* / 1000	Module Options HL - Honeycomb Louver SL - Linear Spread SP - Prismatic Spread SS - Solite Spread SF - Frosted Spread More Accessories Available Fixture Options 010 - 0-10 V Dimming*
		15c	27K / 1050	
		25c	30K / 1100	
		40c	30m* / 1100	
		60c	35K* / 1100	
			35m* / 1100	
			40K* / 1100	
			25K* / 1300	
			27K / 1450	
			30K / 1500	
			30m* / 1500	
			35K* / 1500	
			35m* / 1500	
			40K* / 1500	
			25K* / 1800	
			27K / 1900	
			30K / 2000	
			30m* / 2000	
			35K* / 2000	
			35m* / 2000	
			40K* / 2000	
		Multi-optic	27K / 1400	
		15m	30K / 1450	
		25m	30v / 1450	
		40m	35K* / 1450	
		60m	40K* / 1450	
		Specialty	27K / 750	
		10c	30K / 750	
		Dim-to-Warm	(2700K to 1800K)	
		25c	D27 / 1300	
		40c		

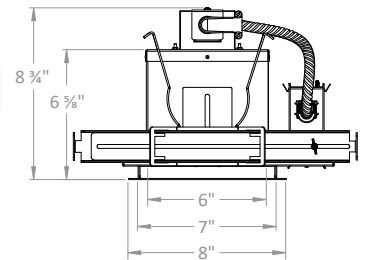

*Consult factory for lead time and availability

PHOTOMETRIC DETAILS | baseline X output multiplier X cri-cct multiplier = final output

COB OPTIC: Baseline for 23 W,
2000 lumens, 80+ CRI, 3000K

Xm20/10c/30K/750

Input Power: 11.2 W
Lumens: 749 lm
Efficacy: 67 lm/W
CBCP: 11648
Beam Angle: 10.6°
Field Angle: 20.8°
Spacing Criteria: 0.19

∠	0°	45°	90°
0°	11648	11648	11648
5°	6264	6089	5926
10°	1275	1202	1208
15°	502	487	477
20°	215	210	202
25°	97	96	93
30°	54	56	52
35°	35	34	31
40°	21	20	19
45°	10	9	10

Xm20/15c/30K/2000

Input Power: 22.7 W
Lumens: 1978 lm
Efficacy: 87 lm/W
CBCP: 15892
Beam Angle: 16.2°
Field Angle: 33.7°
Spacing Criteria: 0.28

∠	0°	45°	90°
0°	15871	15871	15871
5°	12935	12636	12231
10°	5971	5675	5433
15°	2207	2176	2116
20°	1027	977	936
25°	484	473	436
30°	246	252	230
35°	157	157	146
40°	122	115	109
45°	106	99	88

Xm20/25c/30K/2000

Input Power: 22.8 W
Lumens: 1821 lm
Efficacy: 80 lm/W
CBCP: 6729
Beam Angle: 23.3°
Field Angle: 50.4°
Spacing Criteria: 0.41

∠	0°	45°	90°
0°	6729	6729	6729
5°	5937	5855	5779
10°	4081	3975	3895
15°	2348	2291	2231
20°	1274	1228	1203
25°	710	683	676
30°	427	411	404
35°	280	270	265
40°	198	189	187
45°	135	124	124

Xm20/40c/30K/2000

Input Power: 22.4 W
Lumens: 1823 lm
Efficacy: 81 lm/W
CBCP: 3312
Beam Angle: 39.7°
Field Angle: 72.4°
Spacing Criteria: 0.72

∠	0°	45°	90°
0°	3310	3310	3310
5°	3180	3206	3216
10°	2795	2843	2868
15°	2227	2283	2320
20°	1591	1636	1682
25°	1021	1047	1095
30°	603	618	655
35°	347	355	378
40°	207	212	224
45°	131	133	140

Xm20/60c/30K/2000

Input Power: 22.9 W
Lumens: 1990 lm
Efficacy: 87 lm/W
CBCP: 1121
Beam Angle: 53.3°
Field Angle: 91.4°
Spacing Criteria: 1.00

∠	0°	45°	90°
0°	1118	1118	1118
5°	1089	1085	1076
10°	1030	1018	997
15°	937	922	887
20°	799	770	737
25°	632	598	576
30°	460	431	414
35°	308	287	279
40°	201	187	180
45°	126	117	108

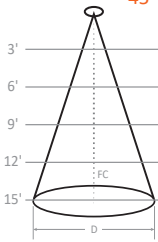

3'	0.56' D; 906 FC	0.85' D; 1234 FC	1.23' D; 523 FC	2.16' D; 257 FC	3.01' D; 87 FC
6'	1.11' D; 227 FC	1.70' D; 309 FC	2.47' D; 131 FC	2.47' D; 64 FC	6.02' D; 22 FC
9'	1.67' D; 101 FC	2.55' D; 137 FC	3.70' D; 58 FC	6.49' D; 29 FC	9.03' D; 10 FC
12'	2.23' D; 57 FC	3.41' D; 77 FC	4.94' D; 33 FC	8.65' D; 16 FC	12.04' D; 5 FC
15'	2.78' D; 36 FC	4.26' D; 49 FC	6.17' D; 21 FC	10.82' D; 10 FC	15.06' D; 4 FC

MULTI-OPTIC: Baseline for 16 W,
1450 lumens, 80+ CRI, 3000K

Xm20/15m/30K/1450

Input Power: 16.2 W
Lumens: 1595 lm
Efficacy: 98 lm/W
CBCP: 18848
Beam Angle: 12.7°
Field Angle: 28.0°
Spacing Criteria: 0.22

∠	0°	45°	90°
0°	18848	18848	18848
5°	11986	12047	12378
10°	4597	4761	4865
15°	1318	1708	1443
20°	449	521	469
25°	227	262	235
30°	165	172	160
35°	102	112	106
40°	70	76	83
45°	37	34	36

Xm20/25m/30K/1450

Input Power: 16.1 W
Lumens: 1525 lm
Efficacy: 95 lm/W
CBCP: 5928
Beam Angle: 26.1°
Field Angle: 49.2°
Spacing Criteria: 0.46

∠	0°	45°	90°
0°	5928	5928	5928
5°	5307	5357	5371
10°	3847	3970	4026
15°	2233	2393	2486
20°	1081	1179	1266
25°	501	554	600
30°	247	278	298
35°	134	152	160
40°	82	89	91
45°	48	54	55

Xm20/40m/30K/1450

Input Power: 16.2 W
Lumens: 1434 lm
Efficacy: 89 lm/W
CBCP: 2886
Beam Angle: 38.2°
Field Angle: 69.9°
Spacing Criteria: 0.69

∠	0°	45°	90°
0°	2886	2886	2886
5°	2813	2786	2753
10°	2422	2405	2364
15°	1922	1923	1882
20°	1409	1408	1385
25°	902	915	905
30°	513	532	524
35°	282	292	291
40°	155	161	161
45°	83	84	84

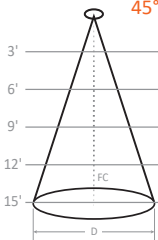

3'	0.67' D; 1466 FC	1.39' D; 461 FC	2.08' D; 225 FC
6'	1.33' D; 367 FC	2.78' D; 115 FC	4.16' D; 56 FC
9'	2' D; 163 FC	4.17' D; 51 FC	6.23' D; 25 FC
12'	2.66' D; 92 FC	5.56' D; 29 FC	8.31' D; 14 FC
15'	3.33' D; 59 FC	6.95' D; 18 FC	10.39' D; 9 FC

CRI-CCT MULTIPLIER

	CRI	CCT	Multiplier
8 (80+)		2200K	0.86
		2500K	0.91
		2700K	0.96
		3000K	1.00
		3500K	1.03
9 (90+)		4000K	1.05
	M (MonoWhite)	2200K	0.70
		2500K	0.77
		2700K	0.83
3000K		0.86	
V (VioLight)	3500K	0.88	
	3000K	0.89	

OUTPUT MULTIPLIER

Package	Multiplier
17 W 1500 lm Xm20 COB-optic	0.82
13 W 1100 lm Xm20 COB-optic	0.77

TM30 COLOR REPORTS

- 3000K with 80+ CRI
- $R_f = 84$; $R_g = 94$
- $R_A = 82$; $R_9 = 11$
- 3000K with 90+ CRI
- $R_f = 92$; $R_g = 100$
- $R_A = 93$; $R_9 = 56$
- 3000K with 97+ CRI
- $R_f = 96$; $R_g = 104$
- $R_A = 97$; $R_9 = 98$
- 3000K with MonoWhite
- $R_f = 91$; $R_g = 100$
- $R_A = 91$; $R_9 = 42$

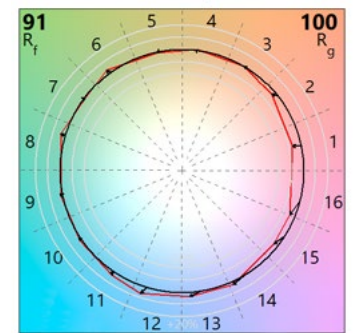
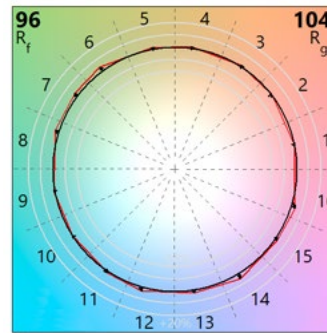
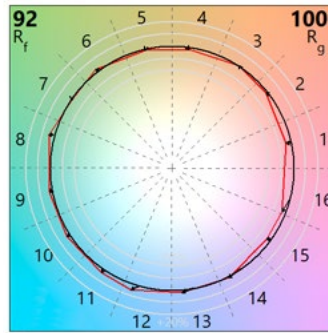
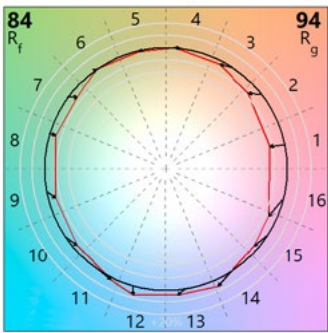
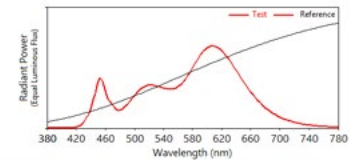
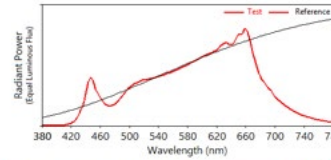
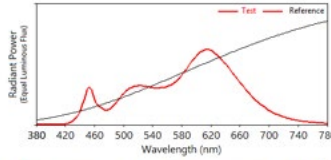
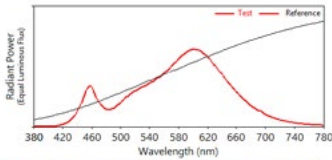

DIM TO WARM DETAILS | Dim to warm only available with 25° and 40° beam spreads; 90+CRI

- 2700K to 1800K with 90+ CRI
- $R_f = 92$; $R_g = 100$
- $R_A = 93$; $R_9 = 57$

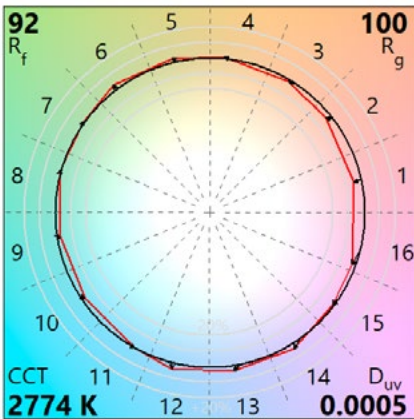
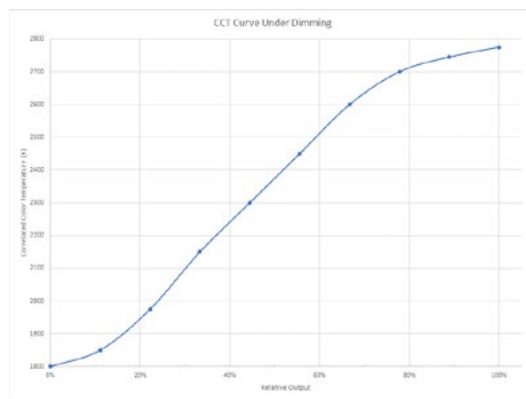
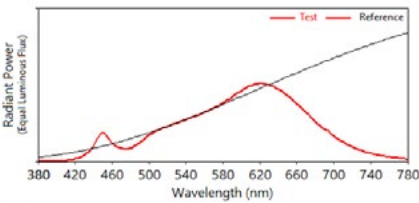

Xm20/25c/D27/1300

Input Power: 18.3 W
Lumens: 1277 lm
Efficacy: 70 lm/W
CBCP: 4427
Beam Angle: 27.9°
Field Angle: 53.1°
Spacing Criteria: 0.50

∠	0°	45°	90°
0°	4410	4410	4410
5°	4262	4250	4150
10°	3388	3404	3243
15°	2218	2252	2097
20°	1234	1269	1166
25°	609	624	577
30°	312	314	289
35°	152	151	141
40°	66	69	65
45°	24	26	25

Xm20/40c/D27/1300

Input Power: 18.3 W
Lumens: 1247 lm
Efficacy: 68 lm/W
CBCP: 2806
Beam Angle: 36.1°
Field Angle: 65.9°
Spacing Criteria: 0.50

∠	0°	45°	90°
0°	2796	2796	2796
5°	2742	2744	2713
10°	2432	2448	2398
15°	1867	1906	1849
20°	1247	1298	1252
25°	749	787	758
30°	423	443	426
35°	231	241	231
40°	116	122	118
45°	56	59	57

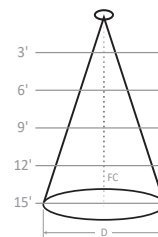

3'	1.49' D; 343 FC	1.95' D; 217 FC
6'	2.98' D; 86 FC	3.90' D; 54 FC
9'	4.47' D; 38 FC	5.86' D; 24 FC
12'	5.96' D; 21 FC	7.81' D; 14 FC
15'	7.45' D; 14 FC	9.76' D; 9 FC

WARNING: Not for use in fully enclosed luminaires. Risk of electric shock. Use in an indoor, dry location only. This device is not intended for use with emergency exit fixtures or emergency exit lights. May not be compatible with all dimmers; please visit solais.com/dimming for up-to-date dimmer compatibility information.

NOTES: This device complies with Part 15 of the FCC Rule. This product may cause interference with other devices. If interference occurs, change the locations of the products involved. **Compatible on 120v systems.**

