

# R-Xm20-WK L1000

X-SERIES | XM20

RETROFIT DOWNLIGHT KIT

PROJECT \_\_\_\_\_

TYPE \_\_\_\_\_

SPECIFICATION \_\_\_\_\_

- Made-to-order product\*
  - Retrofit GU24 Base Whip Kit designed to replace Lightolier 1000 Series Downlights
  - 120 V Standard
  - 0-10 V\*, Triac and ELV dimming
  - 50,000 Hours (L70)
  - Integrated driver
  - UL certified for dry locations
  - RoHs-compliant
  - Contain no lead or mercury
  - **ViOLight** and **\*MonoWhite** color rendering enhancements available
  - **\*90+** High CRI available
- To order, replace 'K' in CCT designation with 'h' in ordering code



**Ordering Information**

Example: R-Xm20/L1000/25/30K/2000/BK/WK/HL

Fixture	Type	Beam Spread	CCT / Lumens	Finish	Kit	Options + Accessories
R-Xm20	L1000	COB-optic	25K* / 1000	WH - White	WK - Whip Kit	HL - Honeycomb Louver
		15c	27K / 1050	BK - Black		SL - Linear Spread
		25c	30K / 1100			SP - Prismatic Spread
		40c	30m* / 1100			SS - Solite Spread
		60c	35K* / 1100			SF - Frosted Spread
			35m* / 1100			More Accessories Available
			40K* / 1100			
			25K* / 1300			
			27K / 1400			
			30K / 1500			
			30m* / 1500			
			35K* / 1500			
			35m* / 1500			
			40K* / 1500			
			25K* / 1800			
			27K / 1900			
			30K / 2000			
			30m* / 2000			
			35K* / 2000			
			35m* / 2000			
			40K* / 2000			
		Multi-optic	27K / 1400			
		15m	30K / 1450			
		25m	30v / 1450			
		40m	35K* / 1450			
		60m	40K* / 1450			
		Specialty	27K / 750			
		10c	30K / 750			
		Dim-to-Warm	(2700K to 1800K)			
		25c	D27 / 1000			
		40c				

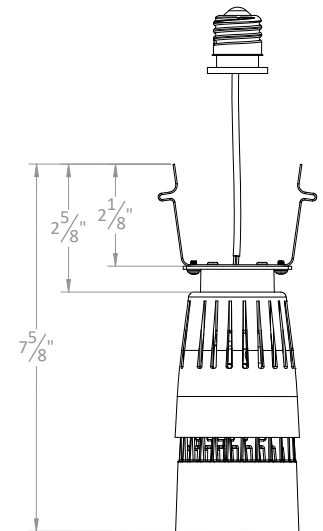
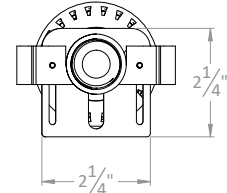

# R-Xm20-WK L1000

X-SERIES | XM20

RETROFIT DOWNLIGHT KIT

PROJECT \_\_\_\_\_

TYPE \_\_\_\_\_

SPECIFICATION \_\_\_\_\_

PHOTOMETRIC DETAILS | baseline X output multiplier X cri-cct multiplier = final output

COB OPTIC: Baseline for 23 W,  
2000 lumens, 80+ CRI, 3000K

**Xm20/10c/30K/750**

Input Power: 11.2 W  
Lumens: 749 lm  
Efficacy: 67 lm/W  
CBCP: 11648  
Beam Angle: 10.6°  
Field Angle: 20.8°  
Spacing Criteria: 0.19

∠	0°	45°	90°
0°	11648	11648	11648
5°	6264	6089	5926
10°	1275	1202	1208
15°	502	487	477
20°	215	210	202
25°	97	96	93
30°	54	56	52
35°	35	34	31
40°	21	20	19
45°	10	9	10

**Xm20/15c/30K/2000**

Input Power: 22.7 W  
Lumens: 1978 lm  
Efficacy: 87 lm/W  
CBCP: 15892  
Beam Angle: 16.2°  
Field Angle: 33.7°  
Spacing Criteria: 0.28

∠	0°	45°	90°
0°	15871	15871	15871
5°	12935	12636	12231
10°	5971	5675	5433
15°	2207	2176	2116
20°	1027	977	936
25°	484	473	436
30°	246	252	230
35°	157	157	146
40°	122	115	109
45°	106	99	88

**Xm20/25c/30K/2000**

Input Power: 22.8 W  
Lumens: 1821 lm  
Efficacy: 80 lm/W  
CBCP: 6729  
Beam Angle: 23.3°  
Field Angle: 50.4°  
Spacing Criteria: 0.41

∠	0°	45°	90°
0°	6729	6729	6729
5°	5937	5855	5779
10°	4081	3975	3895
15°	2348	2291	2231
20°	1274	1228	1203
25°	710	683	676
30°	427	411	404
35°	280	270	265
40°	198	189	187
45°	135	124	124

**Xm20/40c/30K/2000**

Input Power: 22.4 W  
Lumens: 1823 lm  
Efficacy: 81 lm/W  
CBCP: 3312  
Beam Angle: 39.7°  
Field Angle: 72.4°  
Spacing Criteria: 0.72

∠	0°	45°	90°
0°	3310	3310	3310
5°	3180	3206	3216
10°	2795	2843	2868
15°	2227	2283	2320
20°	1591	1636	1682
25°	1021	1047	1095
30°	603	618	655
35°	347	355	378
40°	207	212	224
45°	131	133	140

**Xm20/60c/30K/2000**

Input Power: 22.9 W  
Lumens: 1990 lm  
Efficacy: 87 lm/W  
CBCP: 1121  
Beam Angle: 53.3°  
Field Angle: 91.4°  
Spacing Criteria: 1.00

∠	0°	45°	90°
0°	1118	1118	1118
5°	1089	1085	1076
10°	1030	1018	997
15°	937	922	887
20°	799	770	737
25°	632	598	576
30°	460	431	414
35°	308	287	279
40°	201	187	180
45°	126	117	108

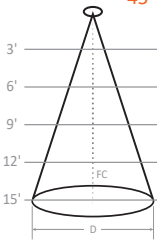

Height	Xm20/10c/30K/750	Xm20/15c/30K/2000	Xm20/25c/30K/2000	Xm20/40c/30K/2000	Xm20/60c/30K/2000
3'	0.56' D; 906 FC	0.85' D; 1234 FC	1.23' D; 523 FC	2.16' D; 257 FC	3.01' D; 87 FC
6'	1.11' D; 227 FC	1.70' D; 309 FC	2.47' D; 131 FC	2.47' D; 64 FC	6.02' D; 22 FC
9'	1.67' D; 101 FC	2.55' D; 137 FC	3.70' D; 58 FC	6.49' D; 29 FC	9.03' D; 10 FC
12'	2.23' D; 57 FC	3.41' D; 77 FC	4.94' D; 33 FC	8.65' D; 16 FC	12.04' D; 5 FC
15'	2.78' D; 36 FC	4.26' D; 49 FC	6.17' D; 21 FC	10.82' D; 10 FC	15.06' D; 4 FC

MULTI-OPTIC: Baseline for 16 W,  
1450 lumens, 80+ CRI, 3000K

**Xm20/15m/30K/1450**

Input Power: 16.2 W  
Lumens: 1595 lm  
Efficacy: 98 lm/W  
CBCP: 18848  
Beam Angle: 12.7°  
Field Angle: 28.0°  
Spacing Criteria: 0.22

∠	0°	45°	90°
0°	18848	18848	18848
5°	11986	12047	12378
10°	4597	4761	4865
15°	1318	1708	1443
20°	449	521	469
25°	227	262	235
30°	165	172	160
35°	102	112	106
40°	70	76	83
45°	37	34	36

**Xm20/25m/30K/1450**

Input Power: 16.1 W  
Lumens: 1525 lm  
Efficacy: 95 lm/W  
CBCP: 5928  
Beam Angle: 26.1°  
Field Angle: 49.2°  
Spacing Criteria: 0.46

∠	0°	45°	90°
0°	5928	5928	5928
5°	5307	5357	5371
10°	3847	3970	4026
15°	2233	2393	2486
20°	1081	1179	1266
25°	501	554	600
30°	247	278	298
35°	134	152	160
40°	82	89	91
45°	48	54	55

**Xm20/40m/30K/1450**

Input Power: 16.2 W  
Lumens: 1434 lm  
Efficacy: 89 lm/W  
CBCP: 2886  
Beam Angle: 38.2°  
Field Angle: 69.9°  
Spacing Criteria: 0.69

∠	0°	45°	90°
0°	2886	2886	2886
5°	2813	2786	2753
10°	2422	2405	2364
15°	1922	1923	1882
20°	1409	1408	1385
25°	902	915	905
30°	513	532	524
35°	282	292	291
40°	155	161	161
45°	83	84	84

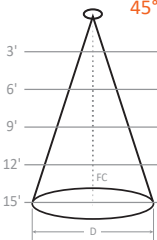

Height	Xm20/15m/30K/1450	Xm20/25m/30K/1450	Xm20/40m/30K/1450
3'	0.67' D; 1466 FC	1.39' D; 461 FC	2.08' D; 225 FC
6'	1.33' D; 367 FC	2.78' D; 115 FC	4.16' D; 56 FC
9'	2' D; 163 FC	4.17' D; 51 FC	6.23' D; 25 FC
12'	2.66' D; 92 FC	5.56' D; 29 FC	8.31' D; 14 FC
15'	3.33' D; 59 FC	6.95' D; 18 FC	10.39' D; 9 FC

CRI-CCT MULTIPLIER

CRI	CCT	Multiplier
8 (80+)	2200K	0.86
	2500K	0.91
	2700K	0.96
	3000K	1.00
	3500K	1.03
9 (90+)	4000K	1.05
	2200K	0.70
	2500K	0.77
	2700K	0.83
M (MonoWhite)	3000K	0.86
	3500K	0.88
	3000K	0.89
V (VioLight)	3000K	0.89

OUTPUT MULTIPLIER

Package	Multiplier
17 W 1500 lm Xm20 COB-optic	0.82
13 W 1100 lm Xm20 COB-optic	0.77

# R-Xm20-WK L1000

X-SERIES | XM20

RETROFIT DOWNLIGHT KIT



PROJECT

TYPE

SPECIFICATION

## TM30 COLOR REPORTS

- 3000K with 80+ CRI
  - $R_f = 84$ ;  $R_g = 94$
  - $R_A = 82$ ;  $R_9 = 11$
- 3000K with 90+ CRI
  - $R_f = 92$ ;  $R_g = 100$
  - $R_A = 93$ ;  $R_9 = 56$
- 3000K with 97+ CRI
  - $R_f = 96$ ;  $R_g = 104$
  - $R_A = 97$ ;  $R_9 = 98$
- 3000K with MonoWhite
  - $R_f = 91$ ;  $R_g = 100$
  - $R_A = 91$ ;  $R_9 = 42$

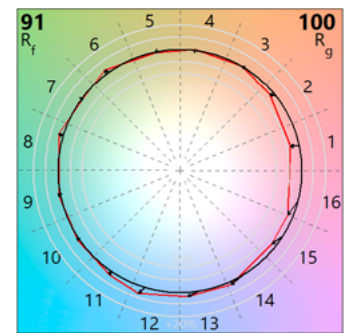
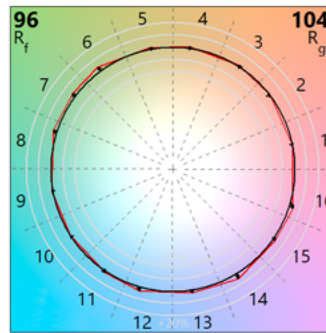
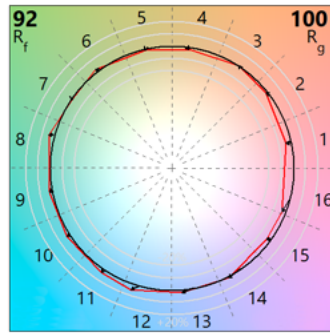
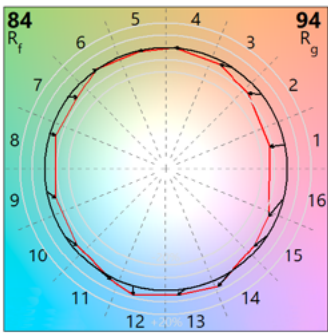
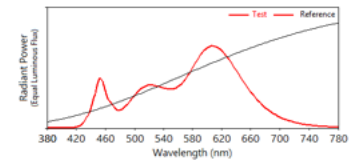
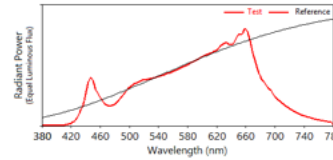
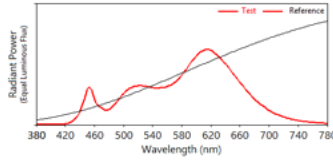
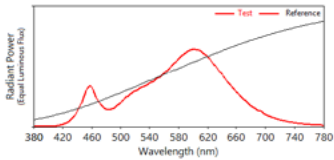

## DIM TO WARM DETAILS | Dim to warm only available with 25° and 40° beam spreads; 90+CRI

- 2700K to 1800K with 90+ CRI
  - $R_f = 92$ ;  $R_g = 100$
  - $R_A = 93$ ;  $R_9 = 57$

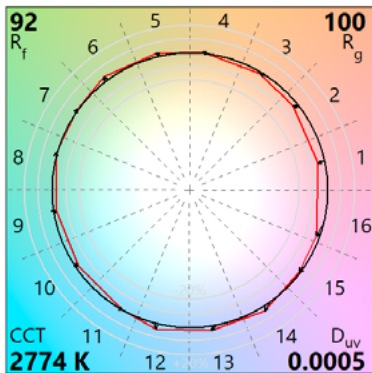
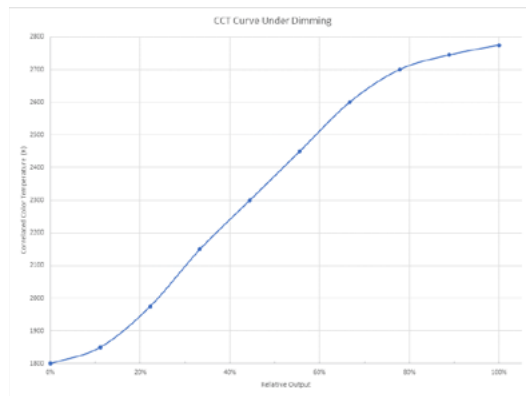
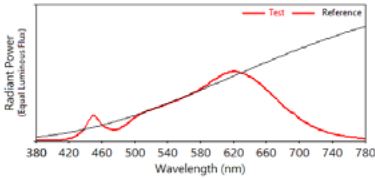

### Xm20/25c/30K/1000

Input Power: 15.7 W  
 Lumens: 1012 lm  
 Efficacy: 65 lm/W  
 CBCP: 3537  
 Beam Angle: 28.0°  
 Field Angle: 53.4°  
 Spacing Criteria: 0.50

∠	0°	45°	90°
0°	3530	3530	3530
5°	3328	3305	3281
10°	2575	2546	2499
15°	1630	1619	1592
20°	894	890	874
25°	441	435	433
30°	222	216	217
35°	106	102	100
40°	43	40	40
45°	9	9	9

### Xm20/40c/30K/1000

Input Power: 15.6 W  
 Lumens: 967 lm  
 Efficacy: 62 lm/W  
 CBCP: 2231  
 Beam Angle: 36.1°  
 Field Angle: 65.0°  
 Spacing Criteria: 0.65

∠	0°	45°	90°
0°	2225	2225	2225
5°	2148	2142	2128
10°	1880	1850	1824
15°	1434	1394	1366
20°	953	920	896
25°	563	540	527
30°	310	296	290
35°	157	152	149
40°	75	72	70
45°	31	30	29

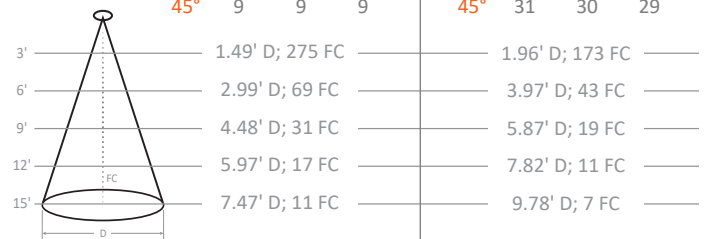

**WARNING:** Not for use in fully enclosed luminaires. Risk of electric shock. Use in an indoor, dry location only. This device is not intended for use with emergency exit fixtures or emergency exit lights. May not be compatible with all dimmers; please visit [solais.com/dimming](http://solais.com/dimming) for up-to-date dimmer compatibility information.  
**NOTES:** This device complies with Part 15 of the FCC Rule. This product may cause interference with other devices. If interference occurs, change the locations of the products involved. **Compatible on 120v systems.**

