

R-XSR12 | RML

X-SERIES | XM24 | RETROFIT

SEMI RECESSED MULTIPLE

PROJECT _____

TYPE _____

SPECIFICATION _____

- Upgrade to modular Solais multiples without complicated re-installation
 - Replacement for:**
 - Zumtobel Staff HID Recessed Multiple Light
 - 120 V standard
 - 0-10 V*, Triac and ELV dimming
 - Modular individually specifiable optics
 - 50,000 Hours (L70)
 - Integrated driver
 - RoHS-compliant
 - UL Certified for dry locations
 - Rated for IC and Non-IC use
 - VioLight and *MonoWhite color rendering enhancements available
 - *90+ High CRI available.
- To order, replace 'K' in CCT designation with 'h' in ordering code.

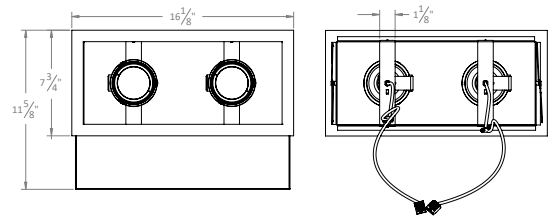
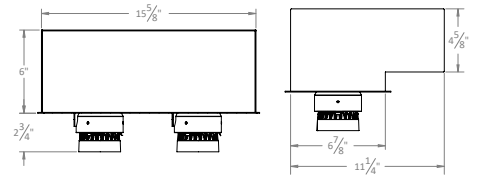

Ordering Information

Example: R-XSR12/RML/Xm24/25-25/30K/2400/WH/WH/SL-SL

1 - 2 1 - 2

Fixture	Type	Module	Beam Spread	CCT / Lumens	Options
R-XSR12	RML	Xm24	COB-optic	25K* / 1400	HL - Honeycomb Louver
			15c	27K / 1550	SL - Linear Spread
			25c	30K / 1600	SP - Prismatic Spread
			40c	30m* / 1600	SS - Solite Spread
			60c	35K* / 1600	SF - Frosted Spread
				35m* / 1600	More Accessories Available
				40K* / 1600	Fixture Options
				25K* / 2000	010 - 0-10 V Dimming*
				27K / 2000	EM - Emergency Backup Microinverter*
				30K / 2000	
				30m* / 2000	
				35K* / 2000	
				35m* / 2000	
				40K* / 2000	
			Multi-optic	30v / 1850	
			15	27K / 2300	
			25	30K / 2400	
			40	35K* / 2400	
			60	40K* / 2400	
				27K / 3000	
				30K / 3000	
				35K* / 3000	
				40K* / 3000	

Trim Finish

- Die-cast, Powder Coated
- WH / WH - White Module, Interior + Flange
- BK / BK - Black Module, Interior + Flange
- BK / WH* - Black Module + Interior, White Flange
- PW / PW* - Perfect White Module, Interior + Flange
- BK / PW* - Black Module + Interior, Perfect White Flange

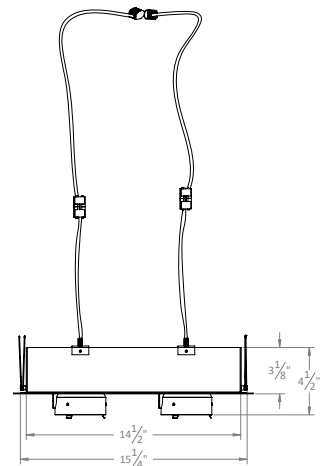

*Consult factory for lead time and availability
 Note: VioLight, MonoWhite and High CRI products will produce up to 20% less measured lumens than their standard CCT equivalent; Although, perceived lumens in VioLight and MonoWhite will be noticeably higher than their standard counterparts.

R-XSR12 | RML

X-SERIES | XM24 | RETROFIT

SEMI RECESSED MULTIPLE

PROJECT

TYPE

SPECIFICATION

PHOTOMETRIC DETAILS | baseline X output multiplier X cri-cct multiplier = final output

COB OPTIC: Baseline data for 22 W, 2000 lumens, 80+ CRI, 3000K

Xm24/15c/30K/2000

Input Power:	22.5 W
Lumens:	1868 lm
Efficacy:	82.9 lm/W
Beam Angle:	19.2°
Field Angle:	49.1°

∠	0°	45°	90°
0°	7831	7831	7831
5°	6438	6425	6339
10°	3671	3628	3524
15°	1830	1823	1789
20°	1088	1090	1069
25°	726	736	709
30°	501	516	496
35°	342	353	344
40°	233	238	236
45°	157	160	163

Xm24/25c/30K/2000

Input Power:	21.9 W
Lumens:	2200 lm
Efficacy:	100.3 lm/W
Beam Angle:	23.9°
Field Angle:	59.8°

∠	0°	45°	90°
0°	6529	6529	6529
5°	5797	5759	5621
10°	4014	3962	3803
15°	2347	2286	2202
20°	1369	1344	1311
25°	904	894	874
30°	646	642	628
35°	458	465	453
40°	332	341	331
45°	241	250	242

Xm24/40c/30K/2000

Input Power:	22.2 W
Lumens:	2013 lm
Efficacy:	90.9 lm/W
Beam Angle:	38.8°
Field Angle:	85.9°

∠	0°	45°	90°
0°	3023	3023	3023
5°	2893	2871	2848
10°	2530	2476	2437
15°	2026	1961	1911
20°	1511	1447	1402
25°	1073	1023	987
30°	749	716	690
35°	527	507	491
40°	380	368	357
45°	278	271	263

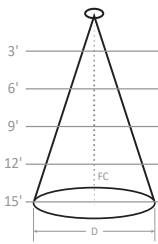

Height	Beam Angle	Field Angle	Diameter (D)	Field of Cut (FC)
3'	0°	45°	1.01'	609 FC
6'	0°	45°	2.03'	152 FC
9'	0°	45°	3.04'	68 FC
12'	0°	45°	4.06'	38 FC
15'	0°	45°	5.07'	24 FC

OUTPUT MULTIPLIER

Package	Optic	Multiplier
18 W 1600 lm Xm24 COB	15°	0.80
	25°	0.80
	40°	0.79

CRI-CCT MULTIPLIER

CRI	CCT	Multiplier
8 (80+)	2200K	0.86
	2500K	0.91
	2700K	0.96
	3000K	1.00
	3500K	1.03
	4000K	1.05
9 (90+)	2200K	0.70
	2500K	0.77
	2700K	0.83
	3000K	0.86
	3500K	0.89
M (MonoWhite)	3000K	0.86
	3500K	0.88
V (VioLight)	3000K	0.89

MULTI-OPTIC: Baseline data for 26 W, 2400 lumens, 80+ CRI, 3000K

Xm24/15/30K/2400

Input Power:	26.4 W
Lumens:	2636 lm
Efficacy:	100.0 lm/W
Beam Angle:	14.8°
Field Angle:	26.1°

∠	0°	45°	90°
0°	32012	32012	32012
5°	23079	22740	22414
10°	7807	8170	8147
15°	1905	1732	1527
20°	642	512	463
25°	268	253	255
30°	157	151	150
35°	99	91	89
40°	72	66	62
45°	55	52	51

Xm24/25/30K/2400

Input Power:	26.4 W
Lumens:	2573 lm
Efficacy:	97.4 lm/W
Beam Angle:	27.2°
Field Angle:	48.4°

∠	0°	45°	90°
0°	9977	9977	9977
5°	9134	9161	9195
10°	6880	6928	6963
15°	4125	4130	4112
20°	1967	1951	1931
25°	824	797	783
30°	367	340	323
35°	191	172	164
40°	111	103	99
45°	69	68	67

Xm24/40/30K/2400

Input Power:	26.4 W
Lumens:	2385 lm
Efficacy:	90.5 lm/W
Beam Angle:	44.0°
Field Angle:	71.7°

∠	0°	45°	90°
0°	4057	4057	4057
5°	4083	3943	3829
10°	3913	3706	3506
15°	3452	3328	3021
20°	2599	2596	2302
25°	1651	1710	1532
30°	913	969	889
35°	456	488	459
40°	221	238	225
45°	112	112	103

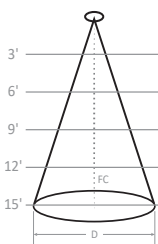

Height	Beam Angle	Field Angle	Diameter (D)	Field of Cut (FC)
3'	0°	45°	0.78'	2490 FC
6'	0°	45°	1.56'	623 FC
9'	0°	45°	2.34'	277 FC
12'	0°	45°	3.12'	156 FC
15'	0°	45°	3.90'	100 FC

OUTPUT MULTIPLIER

Package	Optic	Multiplier
20 W 1850 lm Xm24 Multi-optic	15°	0.70
	25°	0.72
	40°	0.78

Package	Optic	Multiplier
28 W 3000 lm Xm24 Multi-optic	15°	1.13
	25°	1.17
	40°	1.12

R-XSR12 | RML

X-SERIES | XM24 | RETROFIT

SEMI RECESSED MULTIPLE

TM30 COLOR REPORTS

- 3000K with 80+ CRI
- $R_f = 84$; $R_g = 94$
- $R_A = 82$; $R_9 = 11$
- 3000K with 90+ CRI
- $R_f = 92$; $R_g = 100$
- $R_A = 93$; $R_9 = 56$
- 3000K with 97+ CRI
- $R_f = 96$; $R_g = 104$
- $R_A = 97$; $R_9 = 98$
- 3000K with MonoWhite
- $R_f = 91$; $R_g = 100$
- $R_A = 91$; $R_9 = 42$

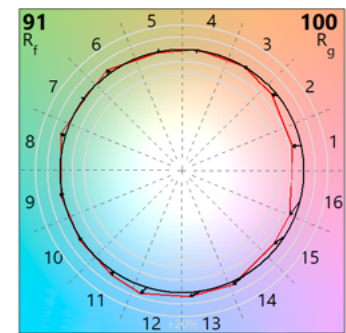
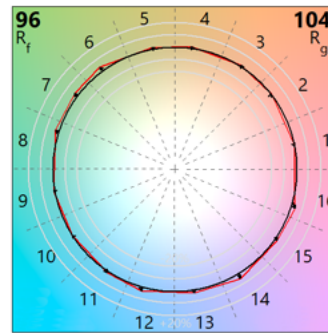
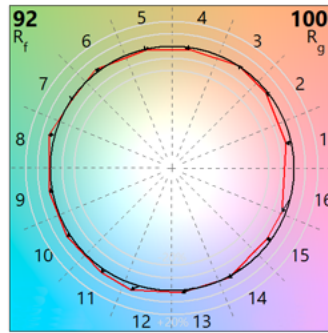
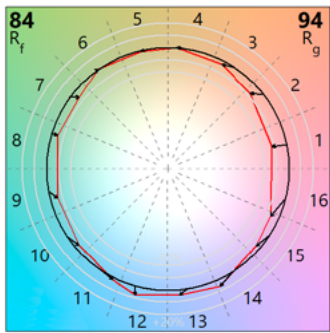
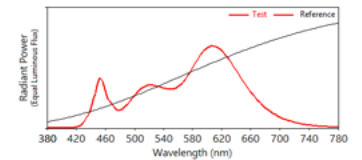
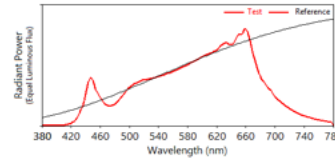
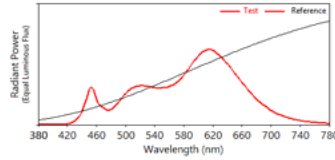
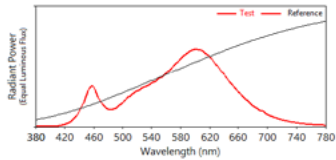

Luxiance utilizes active cooling to remove heat from the LED system - allowing Solais LED lamps to operate cooler, resulting in superior life, light output, and performance.



X-CHANGEABLE

X-Changeable is our all-in-one technology that incorporates the optics, LEDs, driver and power within a replaceable module. This allows you to change the lumen output, color temperature, beam angle and trim color with ease.



THEROTTLE

Thermal Throttle – In the event that Solais products begin to overheat, they will undetectably dim themselves to protect your technology investments.



VIOLIGHT™

VioLight radiates superior quality, enhancing colors in merchandise, making colors more vibrant and offering a truly competitive LED replacement for CMH-like crispness.