

PROJECT \_\_\_\_\_ TYPE \_\_\_\_\_

SPECIFIER \_\_\_\_\_ MEMO \_\_\_\_\_

ORDERING CODE BREAKDOWN

### MAIN FEATURES

- Designed for ease of specification and fast, easy installation
- Available in multiple outputs, CCTs, and up/down illumination options
- Internal 120-277V with 0-10V dim-to-off dimming
- Integral EM backup available
- Variable accessories for pendant, grid, wall and surface mounting options
- 5-year warranty

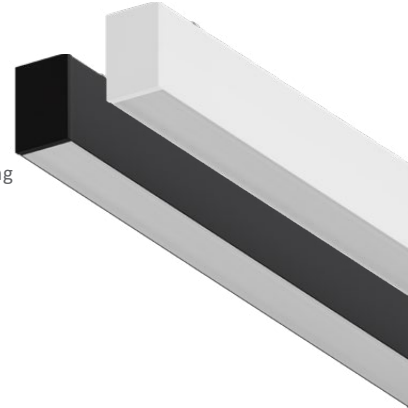

FIXTURE	LENGTH	OPTIC	CRI	CCT	OUTPUT (LM/FT)	DIRECTIONAL OUTPUT <sup>1</sup>	POWER SUPPLY	FINISH	MOUNTING	FIELD OPTIONS					
EZL : EZLine Linear	2F : 2 ft.	DFL : 110° Flush Lambertian	9 : 90+ CRI	FS : Field Selectable	FS : Field Selectable lm/ft	FS <sup>1</sup> : Field Selectable Directional Output	U10 : 120-277V 10% 0-10V Dimming  E10 <sup>3</sup> : 120-277V 10% 0-10V Dimming w/ EM	BK : Black  PW : Perfect White	CM <sup>2</sup> : Canopy Mount, 15 ft. Cable  GM <sup>2,4</sup> : Grid Mount , 15 ft. Cable  WM : Wall/Surface Mount  RM <sup>2</sup> : Recessed Mount Flange	RL <sup>6</sup> : 49 ft. roll, continuous, seamless lens					
	4F : 4 ft.														
	6F <sup>6</sup> : 6 ft.														
	8F : 8 ft.														
	10F <sup>6</sup> : 10 ft.														
	12F <sup>6</sup> : 12 ft.														
	SPECIFIED OPTIONS (PRE-SET FROM FACTORY)														
	14F <sup>6</sup> : 14 ft.										27 : 2700K	1250 : 10W/ft	DIR <sup>1</sup> : 100% Down		
	16F <sup>6</sup> : 16 ft.										30 : 3000K	1000 : 8W/ft	D73 <sup>1</sup> : 70% Down, 30% Up		
	18F <sup>6</sup> : 18 ft.										35 : 3500K	750 : 6W/ft			
	20F <sup>6</sup> : 20 ft.										40 : 4000K	625 : 5W/ft	D55 <sup>1</sup> : 50% Down, 50% Up		
	22F <sup>6</sup> : 22 ft.										50 : 5000K				
	24F <sup>6</sup> : 24 ft.														
	26F <sup>6</sup> : 26 ft.														
	28F <sup>6</sup> : 28 ft.														
	30F <sup>6</sup> : 30 ft.														
	32F <sup>6</sup> : 32 ft.														
	34F <sup>6</sup> : 34 ft.														
	36F <sup>6</sup> : 36 ft.														
	38F <sup>6</sup> : 38 ft.														
40F <sup>6</sup> : 40 ft.															
42F <sup>6</sup> : 42 ft.															
44F <sup>6</sup> : 44 ft.															
46F <sup>6</sup> : 46 ft.															
48F <sup>6</sup> : 48 ft.															

Notes: \*Consult factory for assistance on planning direct runs and or intricate layouts.  
<sup>1</sup> Directional Output is an adjustable ratio of light distribution. Wattage and total output remains constant.  
<sup>2</sup> Canopy Mount Kit and cord options include 15 ft. of suspension material standard. CF for alternate lengths.  
<sup>3</sup> E10 : Battery Backup is unavailable in 2F. Only 1 unit can be added to a continuous run and is field installed. Connectors will not be lit when EM backup is active  
<sup>4</sup> GM : Grid Mount available with Perfect White Canopies and Power Feed; Includes 15 ft. of suspension material standard. Consult factory for other options.  
<sup>5</sup> RM : Recessed Mount Flange is field-paintable and only available in Perfect White, consult factory for alternate needs or continuous runs longer than 8 ft.  
<sup>6</sup> When using connectors, RL - continuous lens is recommended to cut to required length for best fit. Ordered separately.

PROJECT \_\_\_\_\_

TYPE \_\_\_\_\_

### OPTICS + PERFORMANCE

- Field Selectable Performance
  - 2F : 10W - 12W - 16W - 20W (2300 lumens)
  - 4F : 20W - 24W - 32W - 40W (4700 lumens)
  - 8F : 40W - 48W - 64W - 80W (9700 lumens)
- Field Selectable Color Temperatures
  - 90+ CRI: 2700K, 3000K, 3500K, 4000K, 5000K
- Adjustable ratio Direct-Indirect light distribution. Directional Output is an adjustable ratio of light distribution. Wattage and total output remains constant.
  - DIR : 100%/0%
  - D73 : 70%/30%
  - D55 : 50%/50%
- Fixture life: 100,000 hours

### CONSTRUCTION + FINISH

- Weight: 2F 2ft.: 3.4lbs.; 4F 4ft.: 6.2lbs.; 8F 8ft.: 12.3lbs.
- Press-fit connectivity for fast and seamless continuous runs
- Sheet metal housing; Polycarbonate lens
- Standard finishes:
  - White: RAL 9003
  - Black: RAL 9005

### MOUNTING

- CM : Canopy Mount (15ft. Suspension materials standard)
- GM : T-Grid Mount (15ft. Suspension materials standard)
- WM : Wall/surface Mount
- RM : Recessed Mount (field-paintable PW flange)

### ELECTRICAL

- 120-277V Universal with 0-10V dimming to 10%

### LISTINGS

- UL Listed for damp locations
- TAA Compliant
- RoHS-compliant
- Operating temperature: -20°C to 50°C (when suspended 18"+ from ceiling)

### WARRANTY

- 5-year warranty

## INDIVIDUAL COMPONENT SPECIFICATION

FIXTURE	LENGTH	OPTIC	CRI	CCT	OUTPUT (LM/FT)	DIRECTIONAL OUTPUT <sup>1</sup>	POWER SUPPLY	FINISH					
EZL	2F <sup>3</sup> : 2 ft.	DFL : 110° Flush Lambertian	9 : 90+ CRI	FS : Field Selectable	FS : Field Selectable	FS <sup>1</sup> : Field Selectable	U10 : 120-277V 0-10V dimming to 10%	BK : Black PW : Perfect White					
	4F : 4 ft.												
	SPECIFIED OPTIONS (PRE-SET FROM FACTORY)												
	8F : 8 ft.								27 : 2700K	1250 : 10W/ft.	DIR <sup>1</sup> : 100% Down		
									30 : 3000K	1000 : 8W/ft.	D73 <sup>1</sup> : 70% Down, 30% Up		
	35 : 3500K	750 : 6W/ft.	D55 <sup>1</sup> : 50% Down, 50% Up										
	40 : 4000K	625 : 5W/ft.											
	50 : 5000K												

FIXTURE	LIGHTED CONNECTOR	OPTIC	CRI	CCT	OUTPUT (LM/FT)	DIRECTIONAL OUTPUT <sup>1</sup>	FINISH			
EZL	LCN <sup>6</sup> : "L" Connector  TCN <sup>6</sup> : "T" Connector  XCN <sup>6</sup> : "X" Connector	DFL : 110° Flush Lambertian	9 : 90+ CRI	FS : Field Selectable	FS : Field Selectable	FS <sup>1</sup> : Field Selectable	BK : Black PW : Perfect White			
								27 : 2700K	1250 : 10W/ft.	DIR <sup>1</sup> : 100% Down
								30 : 3000K	1000 : 8W/ft.	D73 <sup>1</sup> : 70% Down, 30% Up
								35 : 3500K	750 : 6W/ft.	
								40 : 4000K	625 : 5W/ft.	D55 <sup>1</sup> : 50% Down, 50% Up
	50 : 5000K									

FIXTURE	ACCESSORY	FINISH
EZL	CMP <sup>2</sup> : Canopy Mount Kit with Power	BK : Black PW : Perfect White
	CM <sup>2</sup> : Canopy Mount Kit	
	PC <sup>2</sup> : 5-wire power cord	
	PCE <sup>2</sup> : 6-wire power cord	

FIXTURE	ACCESSORY
EZL	SM : Surface/Wall Mount Kit
	GM <sup>2,4</sup> : Grid Mount Kit
	RM <sup>2,5</sup> : Recessed Mount Kit - for 2F
	RM <sup>4,5</sup> : Recessed Mount Kit - for 4F
	RM <sup>8,5</sup> : Recessed Mount Kit - for 8F
	CK <sup>2</sup> : Cable Kit
	CP : Connection Plate Kit (direct run)
	RL <sup>6</sup> : 49 ft. roll, continuous, seamless lens

- Notes:
- \*Consult factory for assistance on planning direct runs and or intricate layouts.
  - <sup>1</sup> Directional Output is an adjustable ratio of light distribution. Wattage and total output remains constant.
  - <sup>2</sup> Canopy Mount Kits and cord options include 15 ft. suspension material standard. CF for alternate lengths.
  - <sup>3</sup> E10 : Battery Backup is unavailable in 2F. Only 1 unit can be added to a continuous run and is field installed. Connectors will not be lit when EM backup is active
  - <sup>4</sup> GM : Grid Mount available with Perfect White Canopies and Power Feed, consult factory for other options.
  - <sup>5</sup> RM : Recessed Mount Flange is field-paintable and only available in Perfect White, consult factory for alternate needs or continuous runs longer than 8 ft.
  - <sup>6</sup> When using connectors, RL - continuous lens is recommended to cut to required length for best fit. Must be ordered separately.

PROJECT \_\_\_\_\_

TYPE \_\_\_\_\_

### DIMENSIONAL DETAILS

FIXTURE	WEIGHT	LENGTH	WIDTH	HEIGHT
EZL-2F : 2 ft.	3.4 lbs.	24.54 in	2.13 in.	3.36 in.
EZL-4F : 4 ft.	6.2 lbs.	48.12 in.		
EZL-8F : 8 ft.	12.3 lbs	95.71 in.		

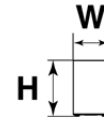
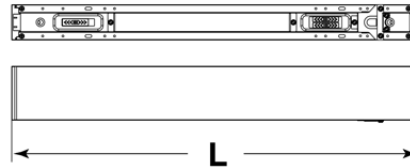

ACCESSORY DETAILS	
<b>EZL-LCN<sup>6</sup></b> 'L' Connector <i>BK - Black or PW- Perfect White</i>	
<b>EZL-TCN<sup>6</sup></b> 'T' Connector <i>BK - Black or PW- Perfect White</i>	
<b>EZL-XCN<sup>6</sup></b> 'X' Connector <i>BK - Black or PW- Perfect White</i>	
<b>EZL-CMP<sup>2</sup></b> Canopy Mount Kit (power) <i>[1] Power Feed Canopy, [2] Screws, [1] Bushing, [1] Cross Bar, [1] 15 ft. Suspension Cable</i> <i>BK - Black or PW- Perfect White</i>	
<b>EZL-CM<sup>2</sup></b> Canopy Mount Kit (non-power) <i>[1] Canopy, [1] Cross Bar, [2] Bolt Anchors, [2] Self-tapping screws, [2] Plastic Anchors, [1] Connection Plate, [1] Rivet Nut, [2] Head Bolts, [1] 15 ft. Suspension Cable</i> <i>BK - Black or PW- Perfect White</i>	
<b>EZL-PC<sup>2</sup></b> 5-wire SJT power cord <i>[1] 15 ft. 300V with female connection Insulated Sheath for dimming wires</i> <i>BK - Black or PW- Perfect White</i>	
<b>EZL-PCE<sup>2</sup></b> 6-wire SJT power cord for use with EM <i>[1] 15 ft. 300V with female connection Insulated Sheath for dimming wires</i> <i>BK - Black or PW- Perfect White</i>	

**EZL-SM**  
 Surface/Wall Mount Kit  
*[2] Surface Mount Brackets, [1] J-box cover plate, [2] Safety Suspension Chains, [2] Hex Head Bolts, [2] Mount Brackets, [10] Self-tapping Screws, [10] Plastic Anchors, [1] 6" 5-wire SJT Power Cord, [10] Screws*

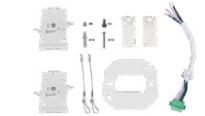

**EZL-GM<sup>2,4</sup>**  
 T-Grid Suspension Mount Kit  
*[2] Type A, twist-on T-Bar Clips, [2] Type B, push-snap T-Bar Clips, [2] Canopies, [1] White Power Feed Canopy, [1] Bushing, [2] Safety Suspension Chains, [2] Connection Plates, [2] Rivet Buts, [4] Head Bolts, [4] Screws*

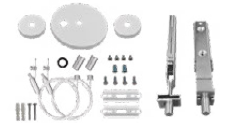

**EZL-RM2<sup>5</sup>**  
 Recessed Mount Kit for 2F  
*[2] Side Plates, [2] End Plates, [4] Spring Clips, [1] Wiring Box Cover Plate, [1] Wiring Box, [1] 6" 5-wire SJT Power Cord, [8] Long Screws, [3] Short Screws*



**EZL-RM4<sup>5</sup>**  
 Recessed Mount Kit for 4F  
*[2] Side Plates, [2] End Plates, [4] Spring Clips, [1] Wiring Box Cover Plate, [1] Wiring Box, [1] 6" 5-wire SJT Power Cord, [8] Long Screws, [3] Short Screws*



**EZL-RM8<sup>5</sup>**  
 Recessed Mount Kit for 8F  
*[2] Side Plates, [2] End Plates, [8] Spring Clips, [1] Wiring Box Cover Plate, [1] Wiring Box, [1] 6" 5-wire SJT Power Cord, [16] Long Screws, [5] Short Screws*



**EZL-CK<sup>2</sup>**  
 Cable Kit  
*[1] Safety Suspension Chain, [1] Self-tapping Screw, [1] Plastic Anchor, [1] Bolt Anchor*



**EZL-CP**  
 Connection Plate Kit (for direct runs)  
*[1] Connection Plate, [1] Rivet Nut, [2] Hex Head Bolts*



**EZL-RL<sup>6</sup>**  
 Continuous Roll Lens  
*49.2 Ft. length of Soft, Continuous Diffuser for Seamless Direct Runs*



## PHOTOMETRIC DETAILS

### 100% DOWN / 0% UP

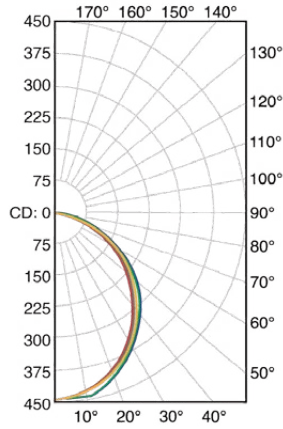

2F @ 10W 4000K			
DOWN		UP	
ANGLE	CBCP	ANGLE	CBCP
0°	440	180°	0
5°	438	175°	0
15°	421	165°	0
25°	382	155°	0
35°	336	145°	0
45°	274	135°	0
55°	209	125°	0
65°	141	115°	0
75°	73	105°	0
85°	18	95°	0
90°	0	90°	0

4F @ 20W 4000K			
DOWN		UP	
ANGLE	CBCP	ANGLE	CBCP
0°	911	180°	0
5°	906	175°	0
15°	867	165°	0
25°	795	155°	0
35°	694	145°	0
45°	573	135°	0
55°	439	125°	0
65°	297	115°	0
75°	157	105°	0
85°	39	95°	0
90°	0	90°	0

8F @ 40W 4000K			
DOWN		UP	
ANGLE	CBCP	ANGLE	CBCP
0°	2,032	180°	0
5°	2,023	175°	0
15°	1,935	165°	0
25°	1,773	155°	0
35°	1,548	145°	0
45°	1,278	135°	0
55°	980	125°	0
65°	662	115°	0
75°	349	105°	0
85°	87	95°	0
90°	1	90°	0

### 70% DOWN / 30% UP

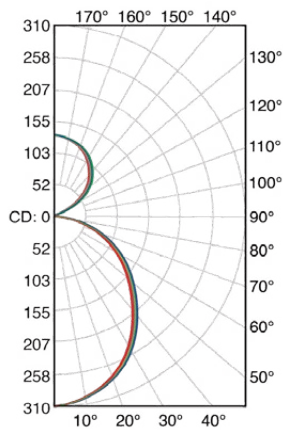

2F @ 10W 4000K			
DOWN		UP	
ANGLE	CBCP	ANGLE	CBCP
0°	306	180°	131
5°	305	175°	130
15°	292	165°	126
25°	267	155°	116
35°	233	145°	104
45°	192	135°	88
55°	147	125°	68
65°	99	115°	46
75°	52	105°	24
85°	13	95°	4
90°	0	90°	0

4F @ 20W 4000K			
DOWN		UP	
ANGLE	CBCP	ANGLE	CBCP
0°	641	180°	263
5°	638	175°	262
15°	611	165°	253
25°	559	155°	235
35°	487	145°	209
45°	401	135°	177
55°	309	125°	138
65°	208	115°	94
75°	110	105°	48
85°	27	95°	27
90°	0	90°	0

8F @ 40W 4000K			
DOWN		UP	
ANGLE	CBCP	ANGLE	CBCP
0°	1,430	180°	587
5°	1,424	175°	585
15°	1,363	165°	564
25°	1,247	155°	525
35°	1,086	145°	467
45°	895	135°	394
55°	689	125°	308
65°	465	115°	211
75°	246	105°	107
85°	61	95°	15
90°	0	90°	0

### 50% DOWN / 50% UP

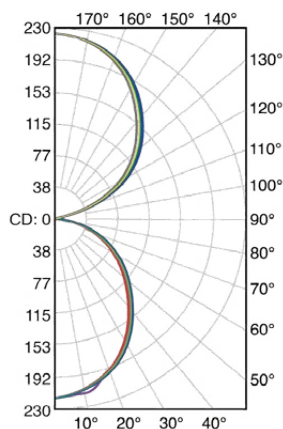

2F @ 10W 4000K			
DOWN		UP	
ANGLE	CBCP	ANGLE	CBCP
0°	214	180°	223
5°	212	175°	221
15°	204	165°	214
25°	186	155°	199
35°	162	145°	176
45°	134	135°	149
55°	102	125°	116
65°	69	115°	79
75°	36	105°	40
85°	9	95°	6
90°	0	90°	0

4F @ 20W 4000K			
DOWN		UP	
ANGLE	CBCP	ANGLE	CBCP
0°	446	180°	452
5°	444	175°	450
15°	427	165°	435
25°	390	155°	405
35°	340	145°	360
45°	279	135°	303
55°	215	125°	237
65°	146	115°	163
75°	76	105°	84
85°	19	95°	13
90°	0	90°	0

8F @ 40W 4000K			
DOWN		UP	
ANGLE	CBCP	ANGLE	CBCP
0°	996	180°	1,008
5°	990	175°	1,005
15°	952	165°	970
25°	870	155°	904
35°	759	145°	804
45°	624	135°	677
55°	479	125°	530
65°	325	115°	363
75°	170	105°	187
85°	42	95°	30
90°	0	90°	0