

LIGHTING TRACK SYSTEMS
2 CIRCUIT / 2 NEUTRAL

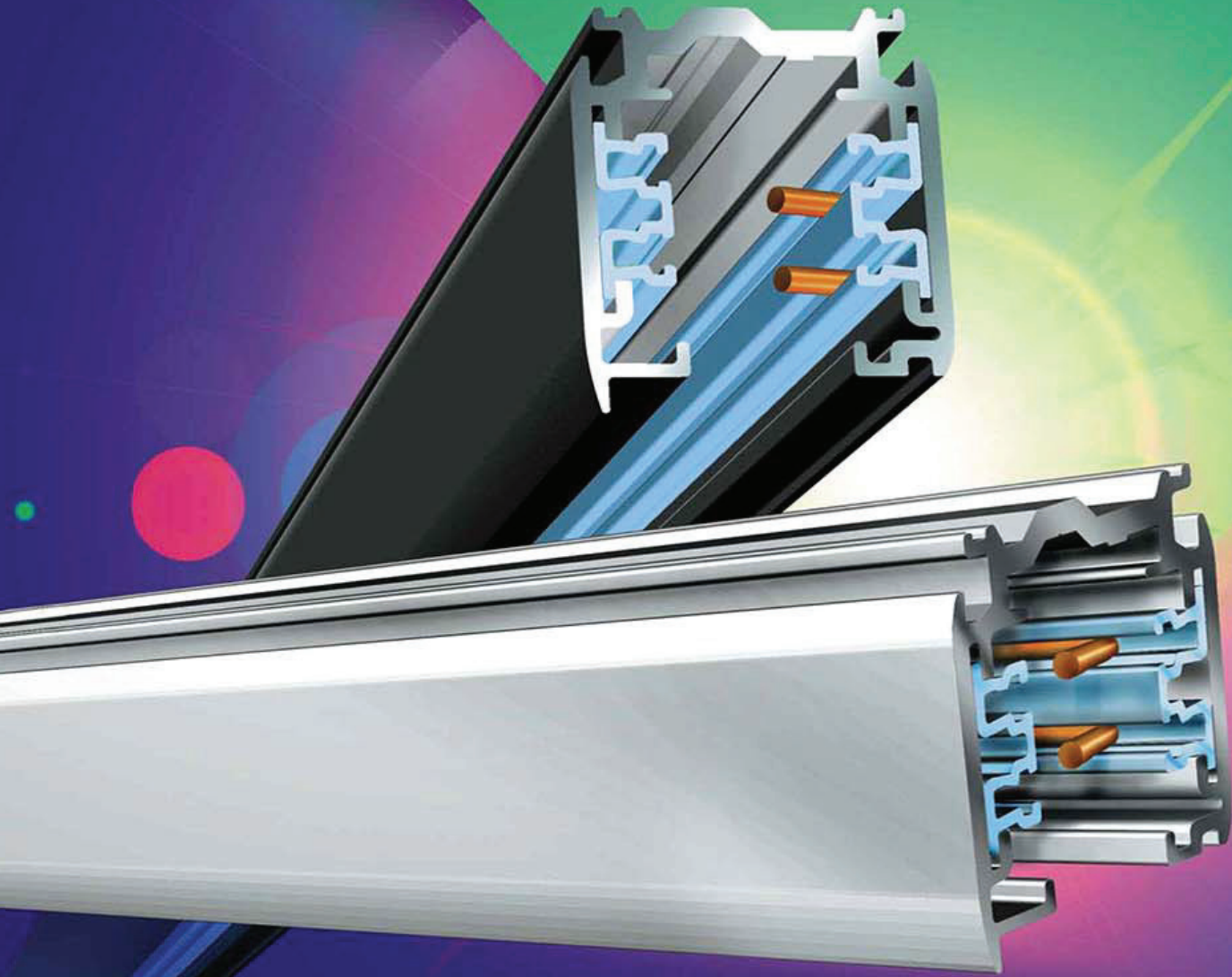

The Power Behind the Fixture.

- Architectural grade
- ISO 9001 quality
- JIT availability
- Open architecture — ready for your fixtures now!

SOLAIS
LIGHTING GROUP

Lighting Track Systems

- High quality, UL listed 2-cct/2-neutral lighting track systems
- Low profile, easy & flexible installation
- Open architecture — ready for any of your fixtures now!

Superior performance for dimmed lighting, low life-cycle cost, and high power handling capability make Global trac GTEK lighting track an excellent choice.

Global trac GTEK 2-cct/2-neutral track is ideal for dimming intensive applications. The independent neutrals guarantee that the two circuits are completely isolated. Cross-circuit interference and neutral harmonics are completely eliminated, essential for trouble free dimming. The lack of harmonics ensures superior fixture performance and longer equipment life. Independent neutrals also offer twice the power handling capacity of ordinary common neutral track.

GLOBAL trac lighting track is engineered to be a durable, dependable, and simple-to-install lighting solution. The track's extruded aluminum construction and continuously crimped conductor ensure mechanical strength and electrical reliability. The integral suspension rail and predrilled mounting holes of the track simplify installations.

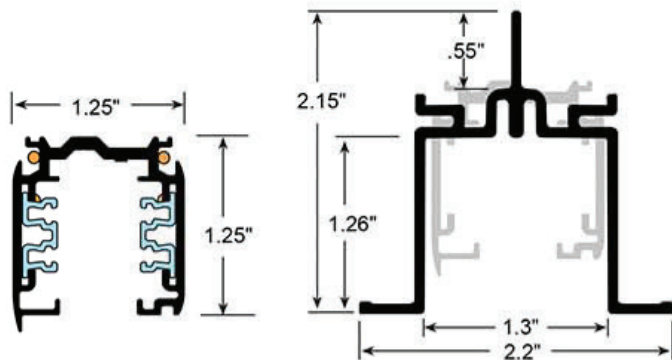
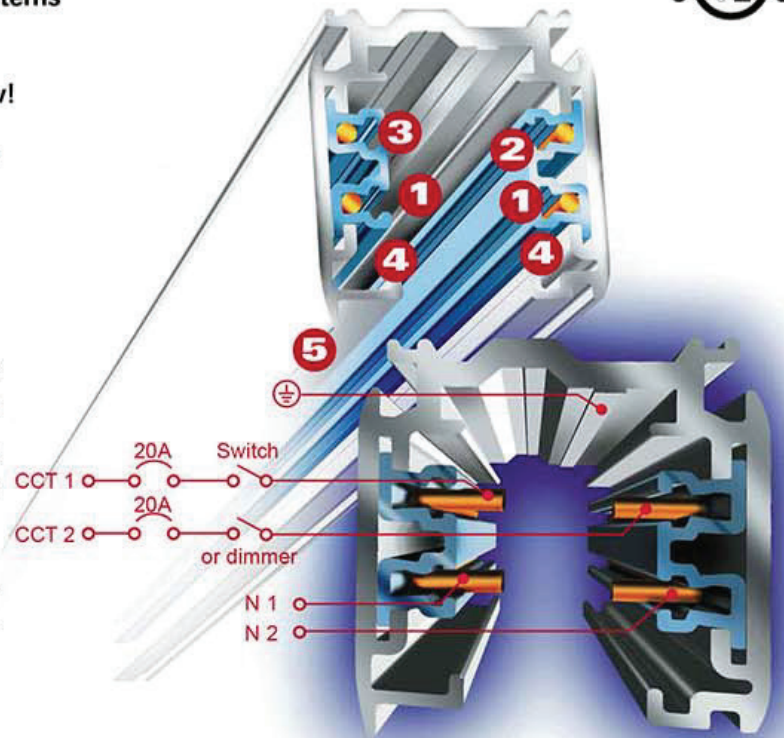

GLOBALtrac tek 2-circuit / 2-neutral track

Track Ordering Information

Lengths* - 4', 8', 12'

Color Codes - White (-WH), Black (-BK), Natural (-NA)

Nominal Lgth	Actual Lgth	Two Circuit #
4-feet	4-feet	GTEK-44-**
8-feet	8-feet	GTEK-48-**
12-feet	12-feet	GTEK-412-**

Example: 8-foot track section in black: GTEK-48-BK

Recessed Track Jacket Ordering Information

Lengths* - 4' 3.5", 8' 3.5", 12' 3.5"

Color Codes - White (-WH), Black (-BK)

Nominal Lgth	Actual Lgth	Jacket #
4-feet	4' 3.5"	GFTP-44-**
8-feet	8' 3.5"	GFTP-48-**
12-feet	12' 3.5"	GFTP-412-**

Example: 8-foot jacket section in black: GFTP-48-BK

- 1** Independent Neutrals - enable greater power capacity (2 x 20A); Dimming capability-dim on two independent circuits without harmonics or interference on the neutral conductor.
- 2** Oversized Conductors - for higher operating safety and reduced overload potential.
- 3** Secure Bus Bar Insulation - firmly crimped insulation secures both conductors and insulation for the life of product
- 4** Separate Mechanical Suspension Points - provides superior weight bearing capacity; ensures electrical contact integrity and reduces likelihood of arcing.
- 5** Polarity Ridge - takes the guesswork out of connector and track alignment during installation.



Color choice

Track available in White, Black or Natural Finish
Components available in White or Black Finish

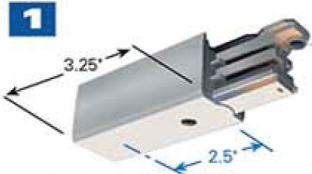
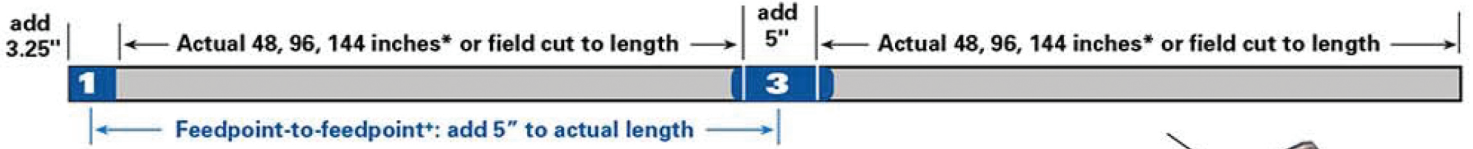
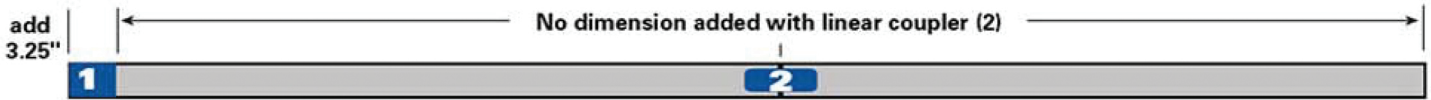
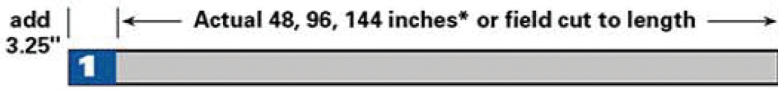

Live End Feed

GTEK-11(-BK,-WH)

Mirror image. GTEK-12(-BK,-WH)



Linear Coupler

GTEK-21(-BK,-WH)



Live Middle Feed

GTEK-14(-BK,-WH)

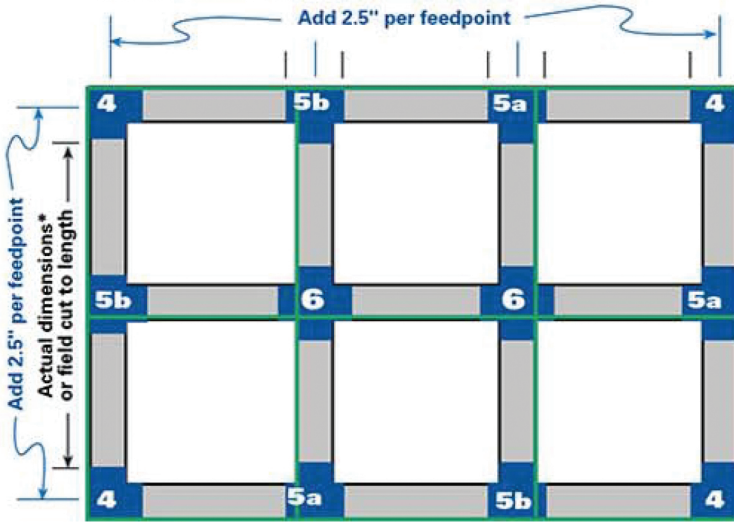

GTEK track is polarized and is manufactured with identifying ridge (green line on diagrams). Refer to these diagrams to ensure proper connector selection.

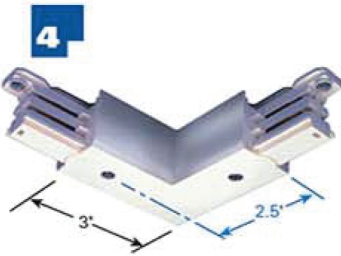
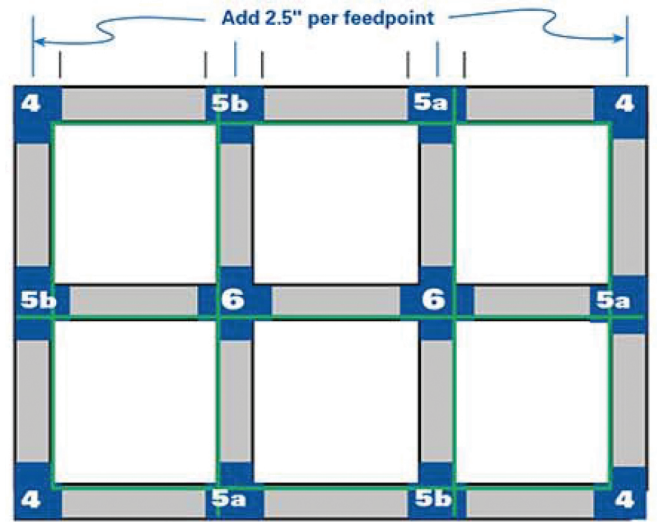

Feedable L-Connector

4a - Adjustable polarity. GTEK-34(-BK,-WH)

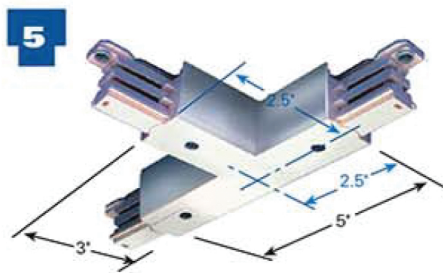

Feedable T-Connector

5a - Adjustable right polarity. GTEK-39(-BK,-WH)

5b - Adjustable left polarity. GTEK-40(-BK,-WH)

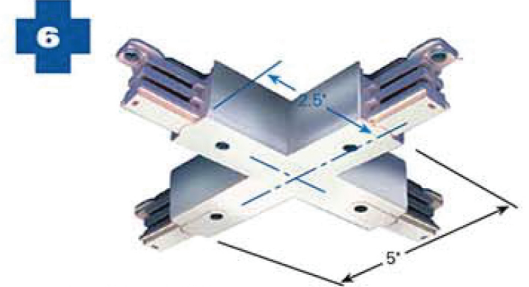

Feedable X-Connector

GTEK-38(-BK,-WH)

Product Ordering Codes: Color - White (-WH), Black (-BK)

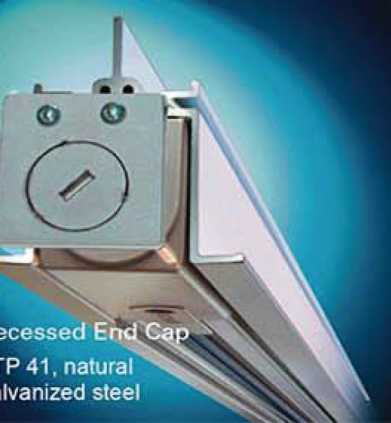

Recessed End Cap
TP 41, natural
galvanized steel

Easy suspension mounting

Track Mounting Clips

for GWB and T-bar ceilings, and easy connection to cable and threaded rod.

Secure recessed mounting

Track Jacket

for safe flush mounting applications.

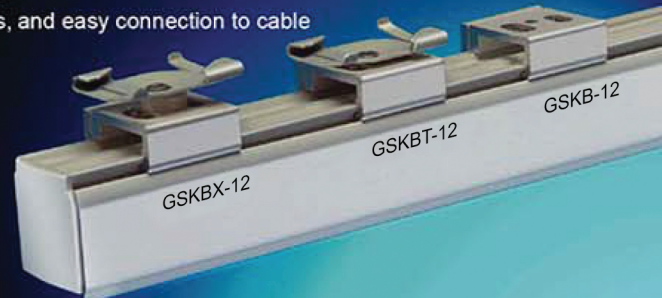

Feeds & Track Accessories...

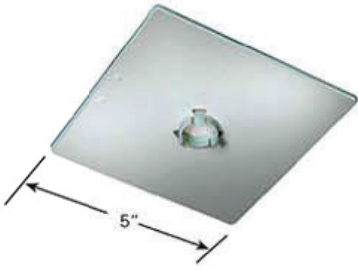

Outlet Box Cover
GGES-15(-BK,-WH)

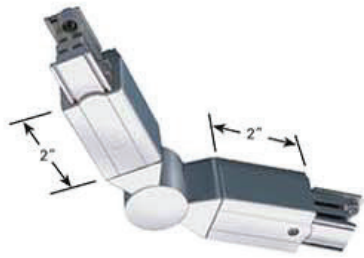

Adjustable Connector
GTEK-24(-BK,-WH)



Track Length & Field Cutting Tool

All-in-one hand tool bends conductors to manufacturer specifications and includes gauge
GXTSV-12



Dead Ends
Must be ordered separately.
GTEK-41(-BK,-WH)

Track Adapters...



Adapter
Non-switchable. Includes built in strain relief.
Max. 20lbs / 600W.
GTEK-67(-BK,-WH)



Adapter
Switchable between circuits & on/off.
Max. 10lbs / 1200W.
GTEK-69(-BK,-WH)



Adapter
Switchable between circuits & on/off.
Includes rotation lock.
Max. 20lbs / 1200W.
GTEK-68(-BK,-WH)

Mounting...

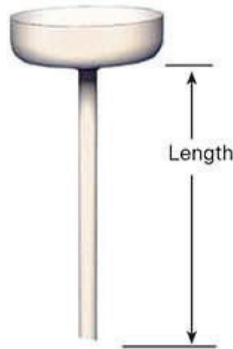

Stem Kits

Includes stem & canopy. Available in 12, 18, 24, 48 inch lengths.
GSP-US-length(-BK,-WH)

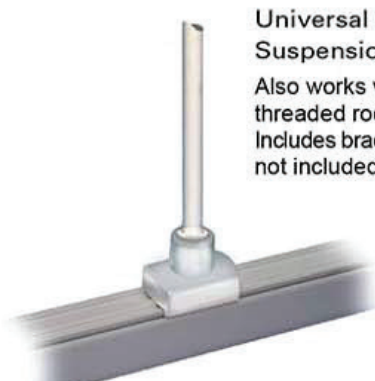

Universal Stem Suspension Point

Also works with cable & threaded rod suspension.
Includes bracket & cover. (Stem not included) GSP-4P(-BK,-WH)

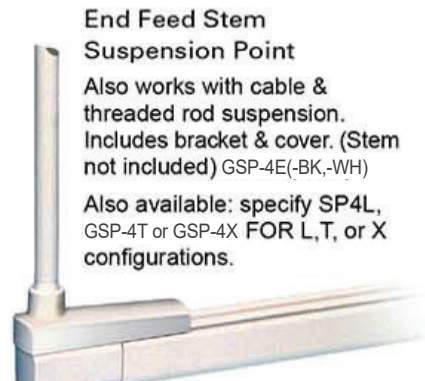

End Feed Stem Suspension Point

Also works with cable & threaded rod suspension.
Includes bracket & cover. (Stem not included) GSP-4E(-BK,-WH)

Also available: specify SP4L, GSP-4T or GSP-4X FOR L, T, or X configurations.

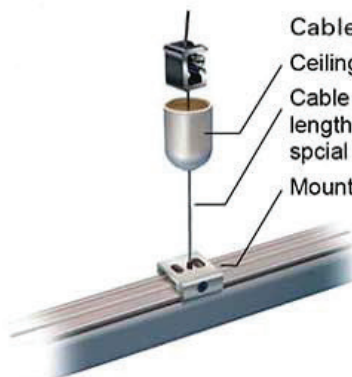

Cable Mount

Ceiling Cup - GSKB-30(-BK,-WH)
Cable (available in 5 or 9" lengths, or custom lengths as special order) - GSKB-34
Mounting Clip - GSKB-12(-BK,-WH)

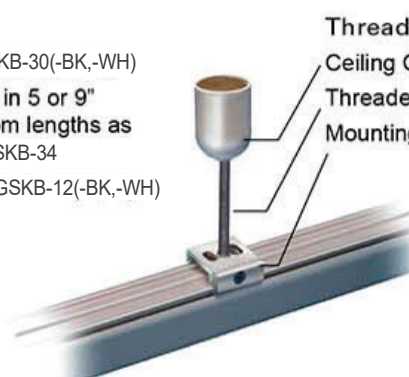

Threaded Rod Mount

Ceiling Cup - GSKB-30(-BK,-WH)
Threaded rod furnished by others
Mounting Clip - GSKB-12(-BK,-WH)

Plastic Covering Tube for threaded rod in 65' rolls - GSKB-32(-BK,-WH)

Current Limiting Device



Current Limiter	Circuit Breaker	Finish
GTEK-11CB - <i>End</i>	005 - 60W, 0.5A	WH - <i>White</i>
<i>Feed</i>	010 - 120W, 1A	BK - <i>Black</i>
	025 - 300W, 2.5A	
	050 - 600W, 5A	
	075 - 900W, 7.5A	
	100 - 1200W, 10A	

